

Diamond Blades

Premium Diamond Blade for Masonry Saw/Dry Cutting

Diameters available: 14", 16", 18", 20"

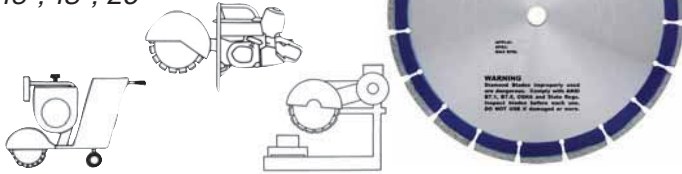

Item #	Code	Diameter	Blade Recommendation	Stock*
LDM3-14X1	NED	14"	Hard brick and tile	Y
LDM-5	NED	—	Medium hard to soft materials	A
LDM-7	NED	—	Soft abrasive block	A
LDM-2P	NED	—	Super premium blade for extra long life and free-cutting hard materials	A
LDM-7P	NED	—	Super premium blade for abrasive block	A

Premium Small Diameter Diamond Blade for Dry Cutting

Diameters available: 4", 4.5", 5", 6", 7", 8", 9", 10"

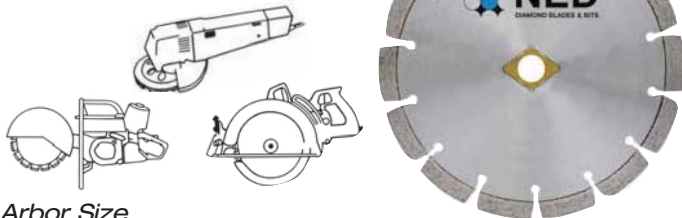

Arbor Size

Blades are available in 1", 7/8", 5/8" universal arbor and 20 mm arbor hole sizes; please specify arbor size when ordering. Nonstandard arbor holes are available upon request.

Item #	Code	Diameter	Blade Recommendation	Stock*
LDX-3	NED	—	Hard material, such as hard brick	A
LDX5-6X58	NED	6"	General cutting of concrete, masonry materials and soft brick	Y
LDX5-8X58	NED	8"	General cutting of concrete, masonry materials and soft brick	A
LDX-7	NED	—	Abrasive material	A
LDX-2P	NED	—	For extra long life and free-cutting hard materials and abrasive concrete	A

G-Series Tuck Point Diamond Blade for Dry Cutting

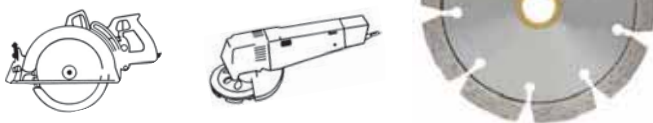

Item #	Code	Diameter	Blade Recommendation	Stock*
GE5-4X250	NED	4"	General cutting	Y



G-Series General Purpose Diamond Blade for Dry/Wet Cutting

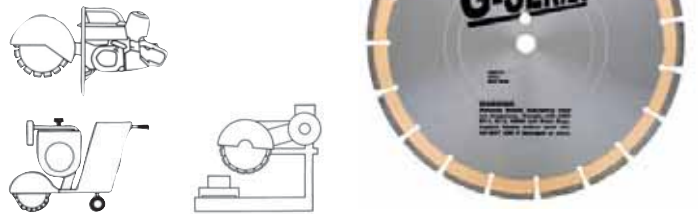

Item #	Code	Diameter	Blade Recommendation	Stock*
G-3	NED	—	Hard material, such as hard brick and pavers	A
G5-4X080X78	NED	4"	General cutting	Y
G5-7X58	NED	7"	General cutting	Y
G5-12X110X1/20	NED	12"	General cutting	A
G5-14X110X1/20	NED	14"	General cutting	A
G-7	NED	—	Abrasive material	A

Continuous Rim Tile Diamond Blade for Wet Cutting

Diameters available: 4", 4.5", 5", 6", 7", 8", 10", 12", 14"

Ned-kut's premium quality continuous rim tile blades are designed for wet cutting on a variety of ceramic, quarry, tile, marble and slate. These blades will give long life with fast, chip-free cutting, even on low horsepower saws.

- 5/8" arbor



Item #	Code	Diameter	Blade Recommendation	Stock*
TK1010	NED	10"	Ceramic tile	Y
TK810	NED	8"	Ceramic tile	Y

*Y = stock item; A = readily available by order

Diamond Blades



Segmented Diamond Cup Wheel for Dry Cutting

- Designed to remove concrete, masonry and stone at an extremely fast rate
- 5/8-11" arbor; 7/8" arbor also available

Sunburst

Item #	Code	Description	Stock*
SUNBURST-412	NED	4 1/2"	Y



Single Row Segments

Item #	Code	Description	Stock*
CUP4-SRG	NED	Standard 4"	Y
0904SRPCW5811	NED	Premium 4"	A
CUP7-SRG	NED	Standard 7"	Y
0907SRPCW5811	NED	Premium 7"	A



Double Row Segments

Item #	Code	Description	Stock*
0904DRSTCWGE5811	NED	Standard 4"	A
0904SRPCW5811	NED	Premium 4"	A
0907DRSTCWGE5811	NED	Standard 7"	A
0907DRPCW5811	NED	Premium 7"	A



Asphalt Diamond Blade

For fast cutting of asphalt, asphalt over concrete, and some abrasive green concrete.

Item #	Code	Diameter	Thickness	Arbor	Stock*
GH10-14X125X1	HUS	14"	.125	1/20 mm	Y



Cut-n-Break Diamond Blade Set

Cuts cured concrete with hard to medium-hard aggregate. Blades have a U-shaped segment design that improves cooling and slurry transportation for better blade speed.

Item #	Code	Diameter	Stock*
576778501	HUS	(2) 9" Diamond Blades for Cut-n-Break Saw	Y



General Purpose Demo Saw Blade



Item #	Code	Diameter	Thickness	Arbor	Stock*
GPS12	MUL	12"	.125	1"	Y
GPS12M	MUL	12"	.125	20 mm	Y
GPS14	MUL	14"	.125	1"	Y
GPS14M	MUL	14"	.125	20 mm	Y

Diamond Tile Bits



Wet/Dry Diamond Tile Bit

Item #	Code	Description	Stock*
012TB	LAC	1/2"	Y
034TB	LAC	3/4"	Y
100TB	LAC	1" w/pilot bit & mandrel	Y
114TB	LAC	1 1/4" w/pilot bit & mandrel	Y
112TB	LAC	1 1/2" w/pilot bit & mandrel	Y



We rent diamond blades and core bits.

See our Rental Department or Web Site for more information and rates.

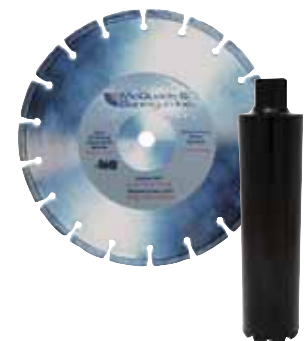

*Y = stock item; A = readily available by order

Diamond Blades



STS-5 Premium Series Multi-Purpose Diamond Blade

One blade cuts everything

- Asphalt, cured/green concrete, block, brick and pavers
- Use wet or dry
- Use with all types of saws



Item #	Code	Diameter	Thickness	Arbor	Stock*
STS5-4X080X78	LAC	4"	.080 mm	7/8"	Y
STS5-412X080X78	LAC	4 1/2"	.080 mm	7/8"	Y
STS5-5X080X78	LAC	5"	.080 mm	7/8"	Y
STS5-12X125X1	LAC	12"	.125 mm	1"	Y
STS5-12X125X20	LAC	12"	.125 mm	20 mm	Y
STS5-14X125X1	LAC	14"	.125 mm	1"	Y
STS5-14X125X20	LAC	14"	.125 mm	20 mm	Y
STS5-16X125X1	LAC	16"	.125 mm	1"	Y
STS5-18X140X1	LAC	18"	.140 mm	1"	Y
STS5-20X140X1	LAC	20"	.140 mm	20 mm	Y
STS5-26X165X1	LAC	26"	.165 mm	1"	Y

High Speed Contractor Diamond Blade

- Designed for dry cutting of cured concrete and masonry applications
- Use with high speed hand-held saws and low horsepower walk-behind saws



Item #	Code	Diameter	Thickness	Arbor	Stock*
SG14SPP141251	LAC	14"	.125 mm	20 mm	Y

Plank-Pro Fiber Cement Diamond Blade



Item #	Code	Diameter	Thickness	Arbor	Stock*
TB7PP	LAC	7"	.070 mm	5/8"	Y
TB10PP	LAC	10"	.080 mm	5/8"	Y



General Purpose Diamond Blade

Turbo rim diamond blade cuts concrete, block, brick and stone.



Item #	Code	Diameter	Thickness	Arbor	Stock*
DB442	BOS	4"	.080	7/8"-5/8" w/insert (included)	Y
DB542	BOS	5"	.080	7/8"-5/8" w/insert (included)	Y
DB742	BOS	7"	.080	5/8" diamond knock out	Y

Double Row Segmented Diamond Cup Wheel

- Use for general purpose or for fast material removal



Item #	Code	Diameter	Arbor	Stock*
DC510	BOS	5"	7/8"	A

Segmented Tuckpointing Diamond Blade

- Use for mortar removal



Item #	Code	Diameter	Arbor	Stock*
DD500	BOS	5"	7/8", 5/8"	Y

Sandwiched Tuckpointing Diamond Blade

- Use for mortar removal and grout removal in commercial tile applications, including waste water treatment plants and subway tunnels



Item #	Code	Diameter	Arbor	Stock*
DD510H	BOS	5"	7/8"	Y

*Y = stock item; A = readily available by order

Diamond Core Bits & Accessories



Premium Wet Drilling Core Bit

- For concrete and general purpose

Item #	Code	Diameter	Stock*
BLACK1	NED	1"	Y
BLACK114	NED	1¼"	Y
BLACK112	NED	1½"	Y
BLACK2	NED	2"	Y
BLACK214	NED	2¼"	A
BLACK212	NED	2½"	Y
BLACK234	NED	2¾"	A
BLACK3	NED	3"	Y
BLACK314	NED	3¼"	A
BLACK312	NED	3½"	Y
BLACK4	NED	4"	Y
BLACK414	NED	4¼"	A
BLACK412	NED	4½"	A
BLACK5	NED	5"	Y
BLACK512	NED	5½"	A
BLACK6	NED	5"	Y
BLACK8	NED	5"	Y
BLACK10	NED	10"	Y



Standard and Super Premium Core Bits are also available



TA114-58

CBE12

Threaded Adapter & Core Bit Extension

Item #	Code	Description	Stock*
TA114-58	NED	1¼"-7 Female to 5/8"-11 Male Threaded Adapter	Y
CBE12	NED	1¼" x 12" Core Bit Extension	Y



Supreme Concrete Dry Cut Core Drill Bit

Item #	Code	Diameter	Stock*
DCBC1.25S	LAC	1¼"	Y
DCBC1.5S	LAC	1½"	Y



*Y = stock item; A = readily available by order

Metal Cutting Blades



Ferrous Metal Cutting Blade

DEWALT metal cutting blades provide clean, fast cuts in a variety of ferrous, nonferrous, and stainless steel materials. Specially designed carbide teeth deliver precise, virtually burr-free cuts and produce cut materials that are cool to the touch.

Features:

- 12% titanium carbide provides long life in metal cutting
- Modified ATB tooth geometry provides clean, burr-free cuts
- Tri-foil braze absorbs stress, making the tip stronger
- Expansion slots dissipate heat, which extends blade life
- For use with metal cutting and dry cut miter saws only



Item #	Code	Diameter	Arbor	# Teeth	Grind	Kerf	Max. RPM	Stock*
DW7747	DEW	14"	1"	70	M-ATB	.087"	1,800	Y

D'AX® Carbide Blade

D'AX blades cut through a variety of difficult to cut materials, and they don't need sharpening—simply reverse and continue cutting. Roofers, renovators, rescue units, landscapers, demolition crews, wreckers/recyclers and farmers will all find many uses for the D'AX blade. Blades fit portable gas and electric hand-held saws and smaller floor type saws.



D'AX carbide blade cuts through:

- Tar, shingle, corrugated and gravel roofs
- Insulation materials
- Dry wall, wood and metal studding
- Fire doors
- Cinder block
- Plastic
- Sheet metal, tin and aluminum
- Auto body panels
- Tree roots
- Ice, frozen materials
- Tires and hard, reinforced rubber
- Expansion joint filler
- Chip board, hard board and press wood
- Countertops
- Pallets, rail ties and timber
- Hardwood flooring and decking
- Cardboard and paperboards



Item #	Code	Diameter	Arbor	Stock*
DAX-12X1X20	DSI	12"	1-20 mm	Y
DAX-14X1X20	DSI	14"	1-20 mm	Y

Metal Cutting Blades

TENRYU

Alumi-Cut Non-Ferrous Metal Cutting Blade

Alumi-Cut blades provide excellent results in aluminum, copper, brass, bronze and other nonferrous metals. Also good for woodworking and plastic cutting when needed. These blades are also an excellent choice for cutting laminated flooring (e.g. Pergo®) with slide-miters or table saws.

Features:

- Fully-hardened, expertly-tensioned tool steel bodies for true and accurate cuts
- Appropriate triple-chip grind pattern for nonferrous metals
- Quality carbide ground to precision



Item #	Code	Diameter	Arbor	# Teeth	Grind	Kerf	Max. RPM	Stock*
AC25580D	TEN	10"	5/8"	80	TCG	.094"	5,870	Y
AC30580D	TEN	12"	1"	80	TCG	.110"	5,000	Y

MORSE

Metal Devil® NXT Metal Cutting Circular Saw Blade

New plate technology and tip design offers consistency, reliability and less vibration

- Stability of plate through manufacturing process produces smoother cuts and longer blade life
- New technology minimizes stress in the carbide tips resulting in longer blade life



Item #	Code	Diameter	Arbor	# Teeth	Tooth Material	Max. RPM	Stock*
CSM842NSC	MOR	8"	5/8"	42	Carbide	5,800	Y

LENOX

Thin Steel Cutting Blade

- Titanium carbide tipped
- Less burr than abrasive blades
- Use for cutting sheet metal, thin walled pipe, metal roofing, metal decking



Item #	Code	Diameter	Arbor	# Teeth	Max. RPM	Stock*
21877	LEN	6 1/2"	5/8"	48	5,800	Y



BOSCH



Rescue Blade

Designed for firefighters and other professionals for fast cutting through shingles, nails, wood and other structural components.

Item #	Code	Diameter	Arbor	# Teeth	Grind	Kerf	Max. RPM	Stock*
PRO1224RES	BOS	12"	1"	24	TCG	.137"	4,700	Y
PRO1224RES20	BOS	12"	1"	24	TCG	.135"	4,700	Y
PRO1424RES	BOS	14"	1"	24	TCG	.144"	4,500	Y



Ferrous Metal Cutting Carbide Blade

Item #	Code	Dia.	Arbor	# Teeth	Grind	Hook Angle	Plate	Kerf	Stock*
CB748ST	BOS	7 1/4"	5/8" Diamond	48	ATB	0	.065"	.079"	Y

PHONE ORDERS & MAIL ORDERS

WILL BE HANDLED PROMPTLY AND ACCURATELY!

You can help us fill your orders correctly by using catalog numbers and the name of the product, along with referring to page numbers in this catalog.

*Y = stock item; A = readily available by order

Metal Cutting Blades

freud

Steel Demon® Ferrous Metal Cutting Blade

Ideal for cutting steel studs, steel sheet, steel pipe and other mild steel sections.

Steel Demon blades efficiently cut through ferrous metals quickly and accurately leaving clean, burr free cuts. These blades feature teeth with Triple Chip Grind (TCG) and a special carbide blend with outstanding resistance to the high impact generated by steel cutting.



Item #	Code	Diameter (in.)	Arbor (in./mm)	# Teeth	Grind	Hook Angle	Kerf (in.)	Stock*
D0530FM	FRE	5 3/8	20 mm	30	TCG	2	.059	Y
D0648F	FRE	6 1/2	5/8" Diamond	48	TCG	2	.071	Y
D0738FM	FRE	7	20 mm	38	TCG	2	.102	Y
D0738F	FRE	7 1/4	5/8"	38	TCG	2	.102	Y
D0748F	FRE	7 1/4	5/8" Diamond	48	TCG	2	.102	Y
D0748FM	FRE	7	20 mm	48	TCG	2	.102	Y
D0756F	FRE	7 1/4	5/8"	56	TCG	2	.102	Y
D1260F	FRE	12	1"	60	TCG	-2	.114	Y
D1472F	FRE	14	1"	72	TCG	-2	.114	Y

Nonferrous Metal Cutting Blade

Ideal for on-the-job cutting of nonferrous metal such as copper pipe, aluminum extrusions, brass plate and plastics.

These thin kerf blades have a Triple Chip Grind (TCG) Tooth Design for long life and a clean, burr-free finish. Diablo's unique anti-vibration design and precision-tensioned steel plate provide critical protection against vibration, allowing these blades to cut smoother and quieter.



Item #	Code	Diameter (in.)	Arbor (in./mm)	# Teeth	Grind	Hook Angle	Kerf (in.)	Stock*
D0756N	FRE	7 1/4	5/8" Diamond	56	TCG	-6	.106	Y
D1080N	FRE	10	5/8"	80	TCG	-5	.094	Y
D1296N	FRE	12	1"	96	TCG	-5	.091	Y

LU89M Thick Nonferrous Metal Blade

- For cutting nonferrous metals such as copper pipe, aluminum extrusions and brass plate
- Custom designed gullets to minimize chip build-up and specially designed micrograin carbide tips and tri-metal brazing for long life and clean cuts
- Freud recommends ample use of a liquid lubricant when cutting



Item #	Code	Diameter	Arbor	# Teeth	Kerf	Coating	Stock*
LU89M010	FRE	10"	5/8"	72 TCG	.122	Silver ICE	Y
LU89M012	FRE	12"	1"	86 TCG	.122	Silver ICE	Y

Thin Stock Nonferrous Metal Blade

- Cuts thin aluminum and other nonferrous metals



Item #	Code	Diameter	Arbor	# Teeth	Kerf	Coating	Stock*
LU90M010	FRE	10"	5/8"	100 TCG	.110	Silver ICE	Y
LU90M012	FRE	12"	1"	120 TCG	.118	Silver ICE	Y

Milwaukee

Ferrous Metal Cutting Blade

Dry cut metal saw blade is designed to cut a variety of ferrous materials 3/32" and thicker, including pipe, angle iron, steel studs and conduit. Hardened alloy steel blade has extra thin kerf and vibration dampening for cleaner, smoother, burr-free cuts.



48-40-4505



48-40-4515

48-40-4520

48-40-4015

Item #	Code	Diameter	Arbor	# Teeth	Tooth Material	Max. RPM	Stock*
48-40-4015	MIL	6 1/2"	5/8"	48	Carbide	4,200	Y
48-40-4505	MIL	14"	1"	72	Carbide	1,800	Y
48-40-4515	MIL	8"	5/8"	42	Cermet	5,000	Y
48-40-4520	MIL	8"	5/8"	50	Cermet	5,000	Y

Don't forget to order

Protective Eyewear

see pages 158-160



Need a specific Item? Give us a call and we can customize your order!

Wood Cutting Blades

Construction Saw Blade

Built for the job site. The DeWALT Construction Saw Blade line includes a full range of thin-kerf blades for long life on the job. Built for durability in the toughest job site applications.

Features:

- Thin kerf for fast and smooth cutting action
- Computer balanced plate reduces vibration for improved accuracy and better finish
- Exclusive wedge shoulder design puts more steel behind each tip for increased durability and accuracy

Miter/Table Saw Blade

Item #	Code	Diameter (in.)	Arbor (in./mm)	# Teeth	Grind	Hook Angle	Plate (in.)	Kerf (in.)	Stock*
Fast Ripping: For fast rip cuts in natural wood, plywood, and wood composites.									
DW3112	DEW	10	5/8	24	ATB	15	.071	.097	Y
General Purpose: For all-purpose cutting in natural wood, plywood, and wood composites.									
DW3114	DEW	10	5/8	40	ATB	15	.071	.097	A
DW3123	DEW	12	1	32	ATB	-5	.071	.097	Y
Fine Crosscuts: For fine crosscuts in natural wood, plywood, and wood composites.									
DW3106	DEW	10	5/8	60	ATB	5	.071	.097	A
Combination Packs: Packs include a general purpose blade and a fine crosscut blade.									
DW3106P5	DEW	10	5/8	32/80	ATB	5	.071	.097	Y
DW3128P5	DEW	12	1	32/80	ATB	-5 /10	.071	.097	Y

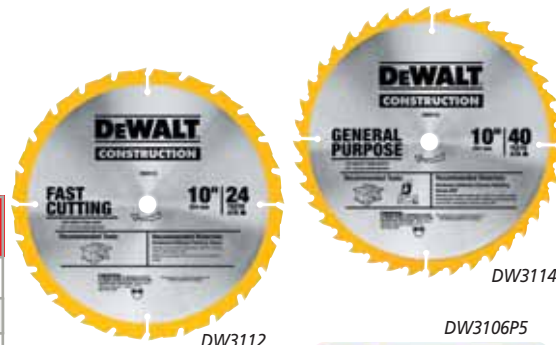

Portable Construction Saw Blade

Item #	Code	Diameter (in.)	Arbor (in./mm)	# Teeth	Grind	Hook Angle	Plate (in.)	Kerf (in.)	Stock*
Combination Framing: For all-purpose cuts in natural wood, plywood, and wood composites.									
DW3161	DEW	6 1/2	5/8	18	ATB	25	.045	.071	A
DW3184	DEW	8 1/4	5/8	40	ATB	15	.050	.076	Y



Cordless Saw Blade

Item #	Code	Diameter (in.)	Arbor (in./mm)	# Teeth	Grind	Hook Angle	Plate (in.)	Kerf (in.)	Stock*
5 3/8" Diameter Blade: Ultra-thin kerf yields more cuts per charge by minimizing battery drain.									
DW9054	DEW	5 3/8	10 mm	24	ATB	20	.039	.059	Y
DW9052	DEW	5 3/8	10 mm	30	FTG	3	.039	.059	A
DW9053	DEW	5 3/8	5/8	78	Alt. Set	-10/45	.039	.059	A
DW9059	DEW	5 3/8	10 mm	30/7824	ATB/Alt Set	18/-45/20	.039	.059	A
6 1/2" Diameter Blade									
DW9154	DEW	6 1/2	5/8	24	ATB	20	.039	.059	Y
DW9158	DEW	6 1/2	5/8	16/24	ATB	20	.039	.059	A



*Y = stock item; A = readily available by order

Wood Cutting Blades

Woodworking Saw Blade

The choice for the finest results. DEWALT Woodworking Saw Blades are designed and manufactured to exacting tolerances for the quality-conscious user who expects accurate cuts, smooth surface finish, and minimal splintering.

Features:

- Large C4 micrograin carbide teeth are precision ground with fine-grit diamond wheels so each tooth planes the wood for an exceptionally smooth finish
- Heavy-gauge, laser-cut hardened and tempered steel plate is precision balanced for accurate cuts producing tight joints
- Ultra-sharp cutting edges dramatically reduce splintering and tear-out
- Extra-hard carbide ensures that cutting edges stay sharp
- Laser-cut expansion slots minimize noise and edge vibration for excellent surface finish

Fine Crosscuts for very smooth crosscuts in plywood, veneer laminates, softwood, and decorative hardwood. Recommended for use with table saws and miter saws.

Item #	Code	Diameter (in.)	Arbor (in.)	# Teeth	Grind	Hook Angle	Plate (in.)	Kerf (in.)	Stock*
DW7646	DEW	10	5/8	60	ATB	10	.098	.118	Y
DW7647	DEW	10	5/8	80	ATB	-5	.098	.118	Y
DW7649	DEW	12	1	80	ATB	-5	.098	.118	A
DW7650	DEW	12	1	96	ATB	-5	.098	.118	A

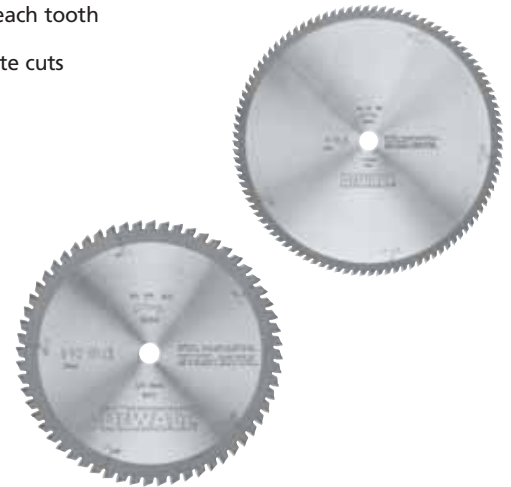

Framing Blade

Item #	Code	Dia. (in.)	Arbor (in.)	# Teeth	Grind	Hook Angle	Plate (in.)	Kerf (in.)	Stock*
CB724AB	BOS	7 1/4	5/8 Diamond	24	ATB	20	.045	.068	A
CB724AB25	BOS	Same as CB724AB – Bulk package of 25 blades.							A

Ultra Thin Kerf Blade

High quality, carbide-tipped blades for crosscutting wood, plywood and other wood products.

Item #	Code	Dia. (in.)	Arbor (in.)	# Teeth	Grind	Hook Angle	Plate (in.)	Kerf (in.)	Stock*
CBCL624A	BOS	6 1/2	5/8	24	ATB	20	.039	.063	Y



Construction Saw Blade

- Rip and crosscut blade has carbide teeth made of C3 grade micro ground carbide and a hardened alloy steel body
- Engineered heat vents and expansion slots prevent blade distortion
- Regular kerf

Item #	Code	Diameter	Arbor	# Teeth	Max. RPM	Stock*
48-40-4170	MIL	10 1/4"	5/8"	28	6,000	Y



Miter Saw Blade

Item #	Code	Dia.	Arbor	# Teeth	Type	Model	Tooth Type	Stock*
998862	HIT	8 1/2"	5/8"	60	Wood	C8FB, C8FB2	TCT, Alt. Top Bevel	Y
725206	HIT	10"	5/8"	72	Wood	C10FM, C10FC2, C10FCD, C10FS, C10A2	TCT, Alt. Top Bevel	A

Wood Cutting Blades

Industrial Series Saw Blades

Freud's industrial series of thin kerf and full kerf blades are designed for the serious woodworker.

Features:

- Laser-cut, anti-vibration slots drastically reduce vibration and sideways movement in the cut, extending blade life and giving a crisp, splinter-free, flawless finish
- High strength steel and precision tensioned bodies ensure stable, flat blades
- Thick, micrograin carbide tips, laser-cut blade bodies and expansion slots
- Kickback reducing design promotes safety
- Blades are available with red Perma-SHIELD® or Silver ICE™ coatings to help reduce friction, heat build-up and gumming

Heavy-Duty Rip Blade

- Gives smooth, fast rips in hard and soft woods for a glue line precision cut
- Ideal working range is from 3/4" to 2 3/4" thick



Item #	Code	Diameter	Arbor	# Teeth	Kerf	Coating	Stock*
LM72M010	FRE	10"	5/8"	24 Flat	.126	Silver ICE	Y
LM72R010	FRE	10"	5/8"	24 Flat	.126	Perma-SHIELD	Y

Heavy-Duty Glue Line Rip Blade

- Triple chip tooth produces extremely smooth, glue line rips in hard and soft woods from 1/8" to 1" thick



Item #	Code	Diameter	Arbor	# Teeth	Kerf	Coating	Stock*
LM74M010	FRE	10"	5/8"	30 TCG	.118	Silver ICE	Y
LM74R010	FRE	10"	5/8"	30 TCG	.118	Perma-SHIELD	Y

Thin Kerf Glue Line Rip Blade

- Triple chip tooth produces extremely smooth, glue line rips in hard and soft woods from 1/8" to 1" thick



Item #	Code	Diameter	Arbor	# Teeth	Kerf	Coating	Stock*
LM75R010	FRE	10"	5/8"	30 TCG	.091	Perma-SHIELD	Y

Thin Kerf Ultimate Cut-Off Blade

- Produces glass smooth surfaces when crosscutting hardwoods and softwoods



Item #	Code	Diameter	Arbor	# Teeth	Kerf	Coating	Stock*
LU74R010	FRE	10"	5/8"	80 ATB	.091	Perma-SHIELD	Y

freud®

Cabinetmaker's Crosscut Blade

- Designed specifically for the professional cabinetmaker—good for crosscutting soft and hard wood, plywood and particle board from 1/2" to 2 3/4" thick



Item #	Code	Diameter	Arbor	# Teeth	Kerf	Coating	Stock*
LU73M010	FRE	10"	5/8"	60 ATB	.126	Silver ICE	Y
LU73M012	FRE	12"	1"	72 ATB	.126	Silver ICE	Y

Thin Kerf Ultimate Plywood & Melamine Blade

- Produces flawless, chip-free edges in veneered plywoods, fine moldings, melamine, laminates and crosscuts in solid woods



Item #	Code	Diameter	Arbor	# Teeth	Kerf	Coating	Stock*
LU79R006M20	FRE	160 mm	20 mm	48 Hi-ATB	.091	Perma-SHIELD	Y

Ultimate Plywood & Melamine Blade

- Use for crisp, splinter-free and chip-free cuts in hard and soft woods, veneered plywoods and double-sided laminates



Item #	Code	Diameter	Arbor	# Teeth	Kerf	Coating	Stock*
LU80R010	FRE	10"	5/8"	80 Hi-ATB	.126	Perma-SHIELD	Y
LU80R012	FRE	12"	1"	96 Hi-ATB	.126	Perma-SHIELD	Y

Heavy-Duty Multi-Purpose Blade

- Crosscuts and rips hard and soft woods with ease, and the triple chip grind makes the blade suitable for cutting man-made wood products, such as chipboard and MDF



Item #	Code	Diameter	Arbor	# Teeth	Kerf	Coating	Stock*
LU82M010	FRE	10"	5/8"	60 TCG	.126	Silver ICE	Y

Wood Cutting Blades

Thin Kerf Combination Blade

- Multipurpose blade has groups of five teeth that include one flat tooth for ripping, followed by four alternate top bevel teeth for crosscutting and a large gullet for effective chip clearance



Item #	Code	Diameter	Arbor	# Teeth	Kerf	Coating	Stock*
LU83R010	FRE	10"	5/8"	50 Comb	.091	Perma-SHIELD	Y

Heavy-Duty Combination Blade

- Multipurpose blade has groups of five teeth that include one flat tooth for ripping, followed by four alternate top bevel teeth for crosscutting and a large gullet for effective chip clearance



Item #	Code	Diameter	Arbor	# Teeth	Kerf	Coating	Stock*
LU84M011	FRE	10"	5/8"	50 Comb	.126	Silver ICE	Y
LU84R011	FRE	10"	5/8"	50 Comb	.126	Perma-SHIELD	Y
LU84R012	FRE	12"	1"	60 Comb	.126	Perma-SHIELD	Y

Ultimate Cutoff Blade

- Unique grind on each tooth actually polishes the material as it cuts, producing glass-smooth finishes when crosscutting hard and soft woods, which eliminates the need to sand



Item #	Code	Diameter	Arbor	# Teeth	Kerf	Coating	Stock*
LU85R008	FRE	8"	5/8"	64 ATB	.116	Perma-SHIELD	Y
LU85R010	FRE	10"	5/8"	80 ATB	.116	Perma-SHIELD	Y
LU85R012	FRE	12"	1"	96 ATB	.116	Perma-SHIELD	Y

Thin Kerf General Purpose Blade

- Crosscuts thick hardwoods, softwoods and thinner stock materials
- Ideal working range is from 3/4" to 3 1/2" thick for crosscutting and 1/4" to 1" thick for ripping



Item #	Code	Diameter	Arbor	# Teeth	Kerf	Coating	Stock*
LU86R006M20	FRE	160 mm	20 mm	20 ATB	.098	Perma-SHIELD	Y
LU86R010	FRE	10"	5/8"	40 ATB	.094	Perma-SHIELD	Y
LU86R012	FRE	12"	1"	48 ATB	.094	Perma-SHIELD	Y

Thin Kerf Sliding Compound Miter Blade

- Provides a superior finish cut with sliding miter and radial arm saws



Item #	Code	Diameter	Arbor	# Teeth	Kerf	Coating	Stock*
LU91R008	FRE	8 1/2"	5/8"	48 ATB	.090	Perma-SHIELD	Y
LU91R010	FRE	10"	5/8"	60 ATB	.090	Perma-SHIELD	Y
LU91R012	FRE	12"	1"	72 ATB	.090	Perma-SHIELD	Y

Plexiglass & Plastics Blade

- Cuts acrylics, polycarbonates and other plastics, leaving a smooth finish without melting



Item #	Code	Diameter	Arbor	# Teeth	Kerf	Coating	Stock*
LU94M010	FRE	10"	5/8"	80 MTCG	.110	Silver ICE	Y

Thin Kerf Double-Sided Laminate/Melamine Blade

- Gives ultra long life and excellent finish on the top and bottom of laminates, melamines and veneered plywood



Item #	Code	Diameter	Arbor	# Teeth	Kerf	Coating	Stock*
LU96R010	FRE	10"	5/8"	80 TCG	.091	Perma-SHIELD	Y

Thin Kerf Crosscut Blade

- Crosscutting blade for fine finish with underpowered saws
- Coated blade pulls 1/3" less on the saw, which translates into 33% more cutting power, and the thin kerf removes less material, resulting in less horsepower required



Item #	Code	Diameter	Arbor	# Teeth	Kerf	Coating	Stock*
LU88R012	FRE	12"	1"	80 ATB	.094	Perma-SHIELD	Y

*Y = stock item; A = readily available by order

Wood Cutting Blades

Diablo® Construction Series Saw Blades

Freud's Diablo saw blades are specially designed to meet the needs of the construction and remodeling market. Diablo saw blades have a thin kerf, making them ideal for portable and low-powered saws on the job site. The Perma-SHIELD® Hi-Performance Coating keeps Diablo blades free from gumming and corrosion, and laser-cut stabilizer vents reduce vibration and heat build-up for more precise cuts and longer cutting life.

freud®

Diablo General Purpose Blade

Ideal for cutting oak, pine, plywood, pressure-treated lumber and beams.



Item #	Code	Diameter (in.)	Arbor (in./mm)	# Teeth	Grind	Hook Angle	Kerf (in.)	Stock*
D1040A	FRE	10	5/8"	40	ATB	15	.098	Y
D1244X	FRE	12	1"	44	ATB	15	.098	Y
D1632X	FRE	16 ⁵ / ₁₆	1"	32	ATB	22	.114	Y

Diablo Combination Blade

Ideal for ripping and crosscutting wood and wood composites for a smooth finish.



Item #	Code	Diameter (in.)	Arbor (in./mm)	# Teeth	Grind	Hook Angle	Kerf (in.)	Stock*
D1050X	FRE	10	5/8"	50	ATB	15	.098	Y

Diablo Framing Blade

Ideal for general construction applications, including fast, efficient ripping and crosscutting.



Item #	Code	Diameter (in.)	Arbor (in./mm)	# Teeth	Grind	Hook Angle	Kerf (in.)	Stock*
D0516X	FRE	5 ³ / ₈	10 mm	16	ATB	18	.049	Y
D0524X	FRE	5 ³ / ₈	10 mm	24	ATB	18	.049	Y
D0620X	FRE	6	1/2"	20	ATB	18	.049	Y
D0624X	FRE	6 ¹ / ₂	5/8" Diamond	24	ATB	18	.059	Y
D0724A	FRE	7 ¹ / ₄	5/8" Diamond	24	ATB	15	.059	Y
D0724DA	FRE	7 ¹ / ₄	5/8" Diamond	24	ATB	15	.059	Y
D0724PX (2-pack)	FRE	7 ¹ / ₄	5/8" Diamond	24	ATB	15	.059	Y
D0824X	FRE	8-8 ¹ / ₄	5/8" Diamond	24	ATB	15	.094	Y

Diablo Ripping Blade

Ideal for general construction applications, including fast, efficient ripping and crosscutting.



Item #	Code	Diameter (in.)	Arbor (in./mm)	# Teeth	Grind	Hook Angle	Kerf (in.)	Stock*
D1024X	FRE	10	5/8"	24	ATB	15	.098	Y

Diablo Fine Finish Blade

Ideal for trim carpenters, Diablo Fine Finish Blades leave a smooth surface that requires little to no sanding.



Item #	Code	Diameter (in.)	Arbor (in./mm)	# Teeth	Grind	Hook Angle	Kerf (in.)	Stock*
D0860S	FRE	8 ¹ / ₂	5/8"	60	ATB	15	.087	Y
D1060X	FRE	10	5/8"	60	ATB	15	.087	Y
D1280X	FRE	12	1"	80	ATB	15	.118	Y

Diablo Finish Blade

Ideal for smooth finish crosscuts in hardwood, softwood or plywood.



Item #	Code	Diameter (in.)	Arbor (in./mm)	# Teeth	Grind	Hook Angle	Kerf (in.)	Stock*
D0436X	FRE	4 ³ / ₈	20 mm	36	ATB	5	.049	Y
D0640X	FRE	6	1/2"	40	ATB	18	.049	Y
D0740A	FRE	7 ¹ / ₄	5/8" Diamond	40	ATB	15	.059	Y
D0840X	FRE	8-8 ¹ / ₄	5/8" Diamond	40	ATB	15	.094	Y
D1296N	FRE	12	1"	96	TCG	-5	.091	Y

Diablo Ultra Finish Blade

Flawless crosscuts in wood with minimal rework. Flawless finish in melamine and veneered plywood.



Item #	Code	Diameter (in.)	Arbor (in./mm)	# Teeth	Grind	Hook Angle	Kerf (in.)	Stock*
D1080X	FRE	10	5/8"	80	Hi-ATB	15	.098	Y

Wood Cutting Blades



Riptide™ Thin Kerf Blade

- Precision ground carbide tipped teeth
- Balanced hardened plate stays true



Item #	Code	Dia. (in.)	Arbor (in.)	# Teeth	Grind	Stock*
12850	PC	6	1/2	18	ATB	Y
12855	PC	6	1/2	40	ATB	A
12870	PC	4 1/2	3/8	20	ATB	Y

Fiber Cement Board Cutting Blades



HardieBlade™ Fiber Cement Blade

Ideal for all fiber cement products.

HardieBlade is the only approved PCD (Polycrystalline Diamond) tipped fiber cement blade recommended by James Hardie Building. HardieBlades are perfect for full-time use in heavy-duty applications like cutting multiple pieces of fiber cement board.



Item #	Code	Diameter (in.)	Arbor (in./mm)	# Teeth	Grind	Hook Angle	Kerf (in.)	Stock*
D0704DH	FRE	7 1/4	5/8"	4 PCD	TCG	10	.071	Y



Solid Surface Blade

- Heavy-duty blade for swirl-free and burn-free cuts in solid surface materials



Item #	Code	Diameter	Arbor	# Teeth	Kerf	Coating	Stock*
LU95R010	FRE	10"	5/8"	72 MTGC	.126	Perma-SHIELD	Y



HandiPlank® Fiber Cement Blade

Specially designed for cutting fiber cement products. Polycrystalline Diamond Teeth (PCD) provide maximum life and durability and lasts 50 times longer than carbide.



Item #	Code	Diameter (in.)	Arbor (in./mm)	# Teeth	Grind	Hook Angle	Kerf (in.)	Stock*
DW3193	DEW	7 1/4	5/8"	6 PCD	FTG	-5	.090	Y

Dadoes



Pro Dado Set

- Produces grooves from 1/4" to 7/8"
- Includes (2) outside blades, (3) 1/8" chippers, (3) spacers, shim set and carrying case



Item #	Code	Diameter	Arbor	# Teeth	Hook Angle	Stock*
SD208	FRE	8"	5/8"	12	-12	Y



Table Saw Dado Cutter Insert

- For use with 13/16" stackable dado/rabbet cutters
- Plastic



Table saw and dado not included

Item #	Code	Description	Stock*
TS1007	BOS	Dado Insert for Table Saw	Y

*Y = stock item; A = readily available by order

Router Bits - Straight/Mortising

Double Flute Straight Bit

Micrograin bit is designed to give excellent smoothness of cut and balanced cutting, with minimal vibration. Positive hook angles for efficient cutting. Strong webbing and heavy cutter backing give superior bit life. Specially designed tip for fast plunge cutting.

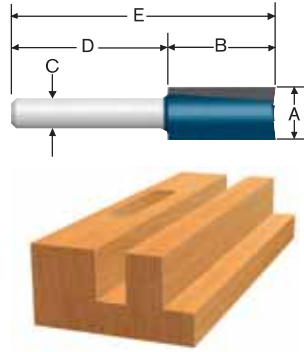

Carbide Tipped

Item #	Code	A Cut Diameter	B Flute Length	C Shank Diameter	D Shank Length	E Overall Length	Stock*
85221MC	BOS	1/4"	5/8"	1/4"	1 1/16"	1 11/16"	A
85250M	BOS	1/4"	7/8"	1/4"	1 1/4"	2 1/8"	Y
85459M†	BOS	1/4"	7/8"	1/4"	1 7/8"	2 7/8"	A
85460M†	BOS	1/4"	7/8"	1/2"	1 7/8"	2 7/8"	A
85613MC†	BOS	1/4"	1"	1/4"	2 1/4"	2 1/2"	Y
85223M	BOS	9/32"	7/8"	1/4"	1"	1 7/8"	A
85224MC	BOS	5/16"	1"	1/4"	1"	2"	Y
85225MC	BOS	3/8"	1"	1/4"	1"	2"	Y
85276M	BOS	3/8"	1"	3/8"	1 3/8"	2 1/2"	A
85241M	BOS	3/8"	1"	1/2"	1 9/16"	2 9/16"	Y
84207M	BOS	3/8"	1 1/4"	1/2"	1 1/4"	2 3/4"	A
85226M	BOS	7/16"	1"	1/4"	1"	2"	A
85227MC	BOS	1/2"	1"	1/4"	1"	2"	Y
85427M	BOS	1/2"	1"	1/2"	1 1/4"	2 7/16"	A
84210M	BOS	1/2"	1 1/4"	1/2"	1 1/4"	2 3/4"	A
85242MC	BOS	1/2"	1 1/2"	1/2"	1 7/16"	2 15/16"	A
85251M	BOS	1/2"	2"	1/2"	2"	4"	Y
85252M	BOS	1/2"	2 1/2"	1/2"	1 3/4"	4 1/4"	A
85229M	BOS	9/16"	1/4"	1/4"	1"	1 5/8"	A
85230MC	BOS	5/8"	5/8"	1/4"	1"	1 5/8"	Y
85454M	BOS	5/8"	1 1/4"	1/2"	1 7/16"	2 11/16"	A
85232MC	BOS	3/4"	5/8"	1/4"	1"	1 5/8"	Y
85265M	BOS	3/4"	1 1/4"	1/2"	1 7/16"	2 7/8"	A
85262M	BOS	1 3/16"	5/8"	1/4"	1"	1 5/8"	A
85457M	BOS	1 3/16"	1 1/4"	1/2"	1 7/16"	2 11/16"	A
85458M	BOS	7/8"	1 1/4"	1/2"	1 7/16"	2 11/16"	A
85243M	BOS	1"	1 1/4"	1/2"	1 7/16"	2 1/16"	A
85465M	BOS	1 1/8"	1 1/4"	1/2"	1 3/8"	3"	A
85466M	BOS	1 1/4"	1 1/4"	1/2"	1 3/8"	3"	A
85469M	BOS	1 1/2"	1 1/4"	1/2"	1 5/8"	2 7/8"	A

†Not guaranteed against breakage because of extreme length.

Solid Carbide

Item #	Code	A Cut Diameter	B Flute Length	C Shank Diameter	D Shank Length	E Overall Length	Stock*
85213MC	BOS	1/8"	3/8"	1/4"	1"	1 9/16"	Y
85214M	BOS	3/16"	1 3/32"	1/4"	1 5/16"	1 5/8"	A
85617M	BOS	1/4"	7/8"	1/4"	7/8"	2 1/4"	A



Single Flute Straight Bit

Micrograin bit is designed for roughing operations where high production feed rates are essential. Optimum chip clearance and specially designed tip allows for fast plunge cutting.

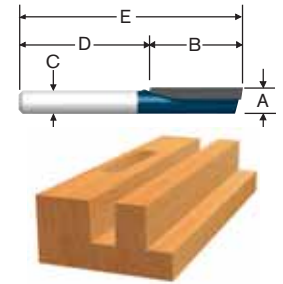

Carbide Tipped

Item #	Code	A Cut Diameter	B Flute Length	C Shank Diameter	D Shank Length	E Overall Length	Stock*
85279MC	BOS	3/16"	1/2"	1/4"	1"	1 5/8"	Y
85410M	BOS	1/4"	1"	1/4"	1 3/8"	2 1/2"	A
85411M	BOS	5/16"	7/8"	1/4"	1 1/4"	2 17/64"	A
85409M	BOS	3/8"	1 1/4"	1/2"	1 7/8"	3 1/8"	A
85425M	BOS	1/2"	1"	1/2"	1 1/4"	2 7/16"	A
85426M	BOS	1/2"	1 1/4"	1/2"	2 3/8"	3 3/16"	A
85264M	BOS	1/2"	2"	1/2"	2"	4"	A

Plywood Mortising Bit

Micrograin bit designed with undersized cut diameters to match up to the actual thickness of 1/4", 1/2", and 3/4" plywood. Produces a tight fit when mortising standard plywood.

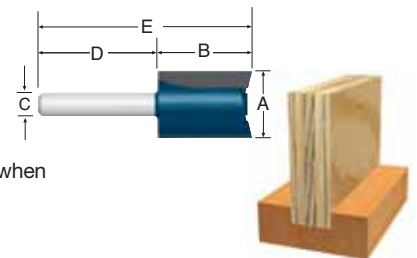

Carbide Tipped

Item #	Code	A Cut Diameter	B Flute Length	C Shank Diameter	D Shank Length	E Overall Length	Stock*
Application: 1/4" plywood							
84600M**	BOS	15/64"	1"	1/4"	1 7/16"	2 1/2"	A
Application: 1/2" plywood							
84601M	BOS	31/64"	1"	1/4"	1 3/8"	2 3/8"	A
84625M	BOS	31/64"	1"	1/2"	1 1/2"	2 1/2"	A
Application: 3/4" plywood							
84602M	BOS	23/32"	1"	1/4"	1 1/4"	2 1/4"	A
84603M	BOS	23/32"	1"	1/2"	1 3/4"	2 3/4"	A

**Solid carbide

Staggertooth Bit

Micrograin bit with staggered cutting flutes gives two-flute balance with single-flute chip clearance for fast plunge cutting.

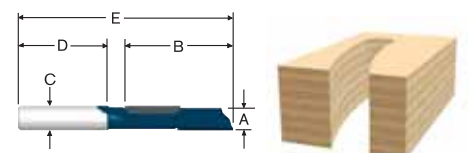

Carbide Tipped

Item #	Code	A Cut Diameter	B Flute Length	C Shank Diameter	D Shank Length	E Overall Length	Stock*
85278M	BOS	1/2"	2 5/16"	1/2"	1 3/4"	4 1/4"	A
85291M	BOS	3/8"	1 5/16"	3/8"	1 7/16"	2 15/16"	A

Router Bits – Mortising

Hinge Mortising Bit

Micrograin bit cuts fast for mortises when work is started at the edge and provides a smooth finish cut that is ideal for surfacing operations. Also useful when good chip clearance is important in material such as gummy wood.

Carbide Tipped Hinge Mortising Bit

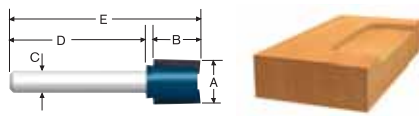

Item #	Code	A Cut Diameter	B Flute Length	C Shank Diameter	D Shank Length	E Overall Length	Stock*
85248MC	BOS	3/4"	3/4"	1/4"	1 1/4"	2"	Y
85249MC	BOS	1/2"	1/2"	1/4"	1 1/2"	2"	Y

Hinge Mortising Bit and Shank (sold separately)

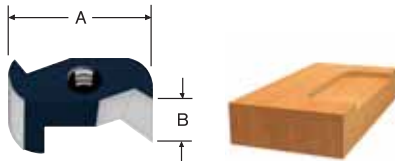

Item #	Code	A Cut Diameter	B Flute Length	Thread	C Shank Diameter	D Shank Length	Stock*
--------	------	----------------	----------------	--------	------------------	----------------	--------

Carbide Tipped Hinge Mortising Bit

85238M	BOS	1 1/4"	1 7/32"	5/16"-24	—	—	A
85234M	BOS	1/2"	1/2"	1/4"-28	—	—	A

Shanks for 85238M Bit

92839	BOS	—	—	5/16"-24	1/4"	1 1/8"	A
92840	BOS	—	—	5/16"-24	1/2"	1 7/8"	A

Shanks for 85234M Bit

82816	BOS	—	—	1/4"-28	1/4"	1 13/16"	A
82817	BOS	—	—	1/4"-28	3/8"	2"	A
82818	BOS	—	—	1/4"-28	1/2"	2 7/16"	A



Stair Routing Bit

Micrograin bit cuts a dovetail-like joint for cutting stair stringers to accept stair treads.

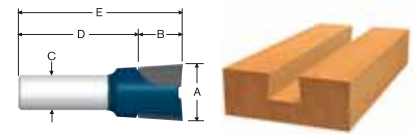

Carbide Tipped

Item #	Code	A Cut Diameter	B Flute Length	C Shank Diameter	D Shank Length	E Overall Length	Angle	Stock*
85413M	BOS	7/8"	5/8"	1/2"	1 3/8"	2 5/16"	3	A

Lock Mortising Bit and Shank

Micrograin bit works with lock mortisers using 1/4"-28 thread. Mounts directly on the spindle shaft of Bosch 1604LM or Porter Cable 513. Shanks for lock mortiser cutters with 1/4"-28 thread allow lock mortising cutters to be used in portable routers.

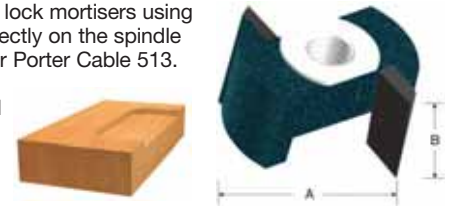

Item #	Code	A Mortise Width	B Cutting Edge Len.	Thread	C Shank Diameter	D Shank Length	Stock*
--------	------	-----------------	---------------------	--------	------------------	----------------	--------

Carbide Tipped Lock Mortising Bit

85634M	BOS	3/4"	1/2"	1/4"-28	—	—	A
85635M	BOS	1"	1/2"	1/4"-28	—	—	A
85636M	BOS	1 1/4"	9/16"	1/4"-28	—	—	A

Shanks (sold separately)

82816	BOS	—	—	1/4"-28	1/4"	1 13/16"	A
82817	BOS	—	—	1/4"-28	3/8"	2"	A
82818	BOS	—	—	1/4"-28	1/2"	2 7/16"	A

Router Bits – Plastic Cutting

Solid Carbide Double-Flute Acrylic Bit

Micrograin bit for cutting single or multiple layers of acrylics and other similar plastics. Special bit geometry produces an improved finish, reduces heat build-up, and prevents welding in the cut.

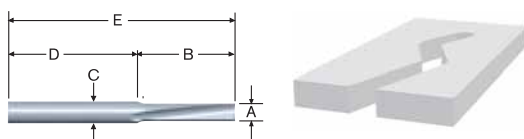

Item #	Code	A Cut Diameter	B Flute Length	C Shank Diameter	D Shank Length	E Overall Length	Stock*
85611M	BOS	1/4"	1"	1/4"	1 1/2"	2 1/2"	A

Solid Carbide Double-Flute O-Flute Bit

Micrograin bit for fast, smooth plastic cutting plastic at high speeds. Ideal for soft plastics such as ABS, polycarbonate, polyethylene and PVC. Double-flute design provides an exceptional edge finish.

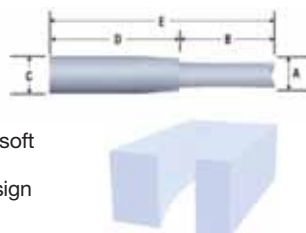

Solid Carbide Single-Flute O-Flute Bit

Micrograin bit for cutting plastic at high speeds. Ideal for soft plastics such as ABS, polycarbonate, polyethylene and PVC. Single-flute design allows for a faster feed rate.

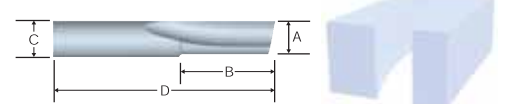

Item #	Code	A Cut Diameter	B Flute Length	C Shank Diameter	D Overall Length	Stock*
85997M	BOS	3/16"	5/8"	1/4"	2"	Y
86002M	BOS	3/8"	1"	3/8"	3"	A

Item #	Code	A Cut Diameter	B Flute Length	C Shank Diameter	E Overall Length	Stock*
86007M	BOS	1/8"	1/2"	1/4"	2"	A
86010M	BOS	1/4"	1"	1/4"	2 1/2"	A

Router Bits – Fiberglass & Drywall



Burr Bit

Solid carbide bit cuts out and shears fibrous materials. Also used to cut epoxies made with carbon, glass and composite materials. Designed with up-and-down cut angles.

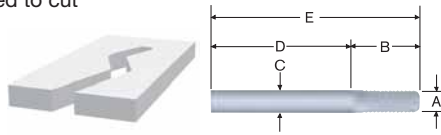

Solid Carbide

Item #	Code	A Cut Diameter	B Flute Length	C Shank Diameter	D Shank Length	E Overall Length	Stock*
85619	BOS	1/4"	3/4"	1/4"	1 1/2"	2 1/2"	A

Router Bits – Laminate Trim

Double-Flute Flush & Bevel Trimming Bit

Micrograin bits ideal for fast, smooth, accurate trim cuts with a shielded, compact ball-bearing pilot.

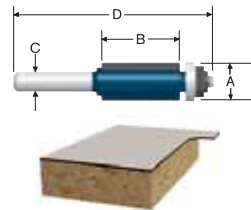

Carbide Tipped

Item #	Code	A Cut Diameter	B Flute Length	C Shank Diameter	D Overall Length	Stock*
85268M	BOS	3/8"	1"	1/4"	2 9/16"	Y
85269M	BOS	3/8"	1/2"	1/4"	2 1/4"	Y
85266M	BOS	1/2"	1"	1/4"	2 3/8"	Y
85267M	BOS	1/2"	5/8"	1/4"	2 5/32"	A
85441M	BOS	1/2"	1"	1/2"	2 5/8"	Y
84500M	BOS	3/4"	9/16"	1/2"	2 1/2"	A
85442M	BOS	1/2"	2"	1/2"	4 1/4"	A

Triple-Flute Laminate Flush Trimming Bit

Micrograin bit provides chatter-free production trimming with extra smooth, flush trim cut. Compact ball-bearing assembly is equipped with glue shield.

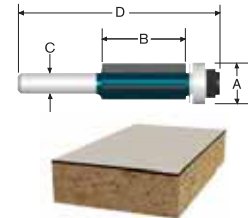

Carbide Tipped

Item #	Code	A Cut Diameter	B Flute Length	C Shank Diameter	D Overall Length	Stock*
85216M	BOS	1/2"	1"	1/4"	2 9/16"	Y

Double-Flute Templet/Trimming Bit

Micrograin bit provides smooth cuts for laminate trimming, cutouts and pattern cutting. Comes with two ball bearings, which can be used together to widen bearing surface and reduce template wear.

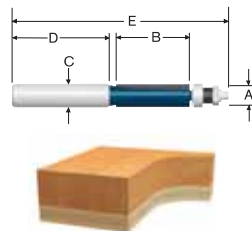

Carbide Tipped

Item #	Code	A Cut Diameter	B Flute Length	C Shank Diameter	D Shank Length	E Overall Length	Stock*
85601M	BOS	1/2"	1 1/2"	1/2"	1 7/8"	4 7/16"	A

Helical Trimming Bit

Provides extra smooth production trimming.

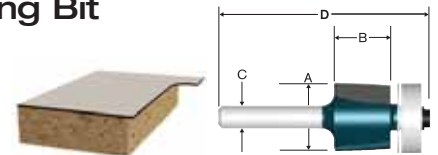

Carbide Tipped

Item #	Code	A Cut Diameter	B Flute Length	C Shank Diameter	D Overall Length	E Type of Cut	Stock*
85452M	BOS	3/4"	5/8"	1/4"	2 1/4"	Flush	A

Overhang Cut-off Bit

Micrograin bit for rough sizing of plastic laminates prior to gluing, without scribing or sawing. Bit leaves slight overhang. Ideal for tops with irregular shapes.

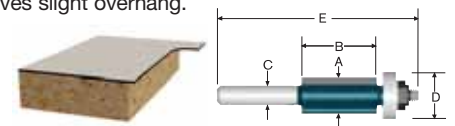

Carbide Tipped

Item #	Code	A Cut Dia.	B Flute Len.	C Shank Dia.	D Bearing Dia.	E Overall Len.	Overhang	Flute	Stock*
85217M	BOS	3/8"	1/2"	1/4"	3/4"	2 1/4"	3/16"	Single	A
85210M	BOS	1/2"	1"	1/4"	5/8"	2 3/8"	1/16"	Double	A

Triple-Flute Trimming Bit

Micrograin bit for laminate trimming and trim cuts on heavier work when cutting with a templet. Can be used with two ball bearings to widen bearing surface and reduce template wear.

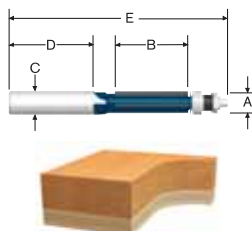

Carbide Tipped

Item #	Code	A Cut Diameter	B Flute Length	C Shank Diameter	D Shank Length	E Overall Length	Stock*
85602M	BOS	1/2"	1 1/2"	1/2"	1 5/8"	4 7/16"	A

*Y = stock item; A = readily available by order

Router Bits - Laminate Trim

Top Bearing-Mounted Straight/Trim Bit

Micrograin bit with top-mounted ball bearing rides against templet for pattern routing.

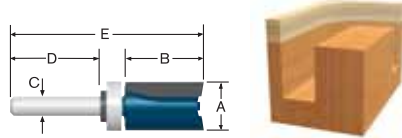

Carbide Tipped

Item #	Code	A Cut Diameter	B Flute Length	C Shank Diameter	D Shank Length	E Overall Length	Stock*
85680MC	BOS	1/2"	1"	1/4"	7/8"	2 1/2"	Y
85681M	BOS	5/8"	1"	1/4"	7/8"	2 1/2"	A
85682MC	BOS	3/4"	1"	1/4"	3/4"	2 1/2"	Y

Double-Flute Trimmer Assembly

Micrograin bit for fast, accurate trim cuts.

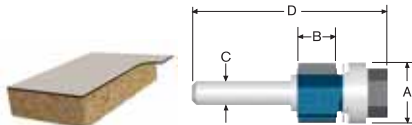

Carbide Tipped

Item #	Code	A Bearing Diameter	B Flute Length	C Shank Diameter	D Overall Length	Type of Cut	Stock*
85430M	BOS	5/8"	3/8"	1/4"	1 15/16"	Flush	A
85431M	BOS	5/8"	3/8"	1/4"	1 15/16"	10° Bevel	A

Triple-Flute Flush and Bevel Trimmer Assembly

Micrograin bit for extra smooth production trimming. Assembly includes arbor, replaceable three-wing cutter and ball bearing.

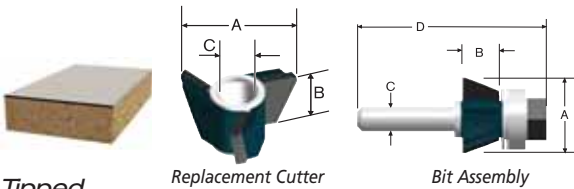

Carbide Tipped

Item #	Code	A Bearing Diameter	B Flute Length	C Bit Shank/Cutter Arbor Diameter	D Overall Length	Type of Cut	Stock*
3-Flute Flush & Bevel Laminate Trimmer Assembly							
85421M	BOS	5/8"	3/8"	1/4"	1 15/16"	Flush	A
85422M	BOS	3/4"	3/8"	1/4"	1 15/16"	9° Bevel	A
85420M	BOS	7/8"	3/8"	1/4"	1 15/16"	22° Bevel	A
85423M	BOS	1"	1/4"	1/4"	1 15/16"	45° Bevel	A
3-Flute Replacement Cutter							
85509M	BOS	Replacement cutter for 85421M					A
85516M	BOS	Replacement cutter for 85422M					A
85511M	BOS	Replacement cutter for 85420M					A
85512M	BOS	Replacement cutter for 85423M					A

Four-Flute Trimmer Assembly

Micrograin bit for ultra-smooth finish trimming. Ball bearing is equipped with glue shield. Components are individually replaceable.

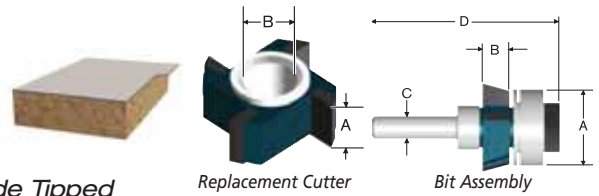

Carbide Tipped

Item #	Code	A Bearing Diameter	B Flute Length	C Bit Shank/Cutter Arbor Diameter	D Overall Length	Type of Cut	Stock*
4-Flute Trimmer Assembly							
85414M	BOS	7/8"	5/16"	1/4"	2 1/4"	Flush	A
85415M	BOS	7/8"	3/8"	1/4"	2 1/4"	15° Bevel	A
4-Flute Replacement Cutter							
85509M	BOS	Replacement cutter for 85414M, 85416M					A

Four-Flute Double Flush Trimmer Assembly

Micrograin bit for flush trimming laminates on both sides of a piece in a single pass. Spacers (provided) adjust distance between cutters to give width of cut 1/2" to 1 1/2". Four flutes give ultra-smooth finish.

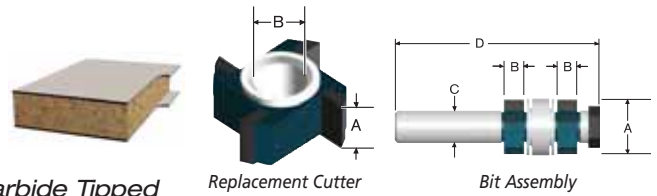

Carbide Tipped

Item #	Code	A Bearing Diameter	B Flute Length	C Bit Shank/Cutter Arbor Diameter	D Overall Length	Type of Cut	Stock*
4-Flute Double Flush Trimmer Assembly							
85416M	BOS	7/8"	5/16"	1/2"	3 5/16"	Flush	A
4-Flute Replacement Cutter							
85417M	BOS	Replacement cutter for 85416M					A

Flush Trimmer Bit

Self-piloting bit makes flush, trim and edge cuts.

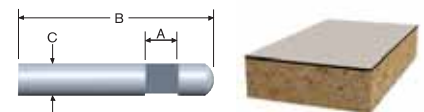

Solid Carbide

Item #	Code	A Flute Length	B Overall Length	C Shank Diameter	Type of Cut	Stock*
85285MC	BOS	1/4"	1 1/2"	1/4"	Flush	Y

*Y = stock item; A = readily available by order

Router Bits - Laminate Trim

Bevel Trimmer Bit

Provides 7½° bevel on trim edge of plastic laminate surfaces. Self-pilot eliminates guide assembly.

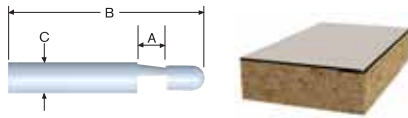

Solid Carbide

Item #	Code	A Flute Length	B Overall Length	C Shank Diameter	Type of Cut	Stock*
85286MC	BOS	¼"	1½"	¼"	7½° Bevel	A

Hole and Flush Cut Trimmer Bit

Drills through surface lamination into precut opening and trims edge flush in one operation.

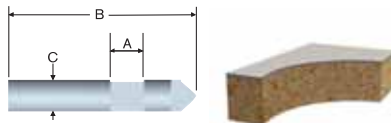

Solid Carbide

Item #	Code	A Flute Length	B Overall Length	C Shank Diameter	Type of Cut	Stock*
85287	BOS	¼"	1½"	¼"	Flush	A

Combination Flush and 22° Bevel Trimmer Bit

Micrograin bit combines bevel or flush trim cuts in one bit. Use with router guide assembly.

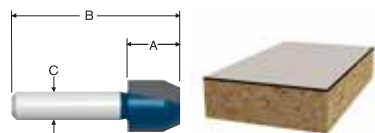

Carbide Tipped

Item #	Code	A Flute Length	B Overall Length	C Shank Diameter	Type of Cut	Stock*
85261M	BOS	29/64"	129/64"	¼"	Flush or 22° Bevel	A

Combination Flush and 10° Bevel Trimmer Bit

Use for 10° bevel or flush, trim edge cuts. Use with router guide assembly.

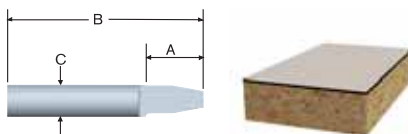

Solid Carbide

Item #	Code	A Flute Length	B Overall Length	C Shank Diameter	Type of Cut	Stock*
85288	BOS	13/32"	15/8"	¼"	Flush or 10° Bevel	A

Rip Bit and Slotter

Use for slotting or ripping sheets of laminate, wood and paneling.

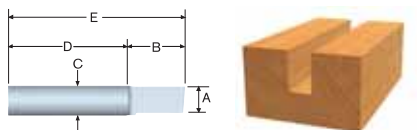

Solid Carbide

Item #	Code	A Cut Diameter	B Flute Length	C Shank Diameter	D Shank Length	E Overall Length	Stock*
85280M	BOS	¼"	5/8"	¼"	1¼"	15/8"	A

Router Bits - Pilot Panel Bits

Pilot Panel Bit w/Drill-Through Point - Single Flute

For window and door cutouts in abrasive insulation materials, plywood and paneling. Drill-through pilot for guiding on template or framing after panel has been mounted.

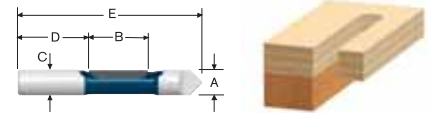

Carbide Tipped

Item #	Code	A Cut Diameter	B Flute Length	C Shank Diameter	D Shank Length	E Overall Length	Stock*
85244	BOS	¼"	¾"	¼"	1"	29/16"	A
85244M	BOS	¼"	¾"	¼"	1"	29/16"	Y
85245	BOS	3/8"	7/8"	3/8"	111/32"	3"	A
85245M	BOS	3/8"	7/8"	3/8"	111/32"	3"	Y
85246	BOS	½"	1 1/8"	½"	131/64"	29/16"	A
85246M	BOS	½"	1 1/8"	½"	131/64"	3"	Y
85407M	BOS	½"	2"	½"	1¾"	4¾"	A

Pilot Panel Bit w/Drill-Through Points - Two Flutes

Two flutes give smooth cuts and even feed rates without chatter.

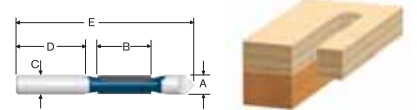

Carbide Tipped

Item #	Code	A Cut Diameter	B Flute Length	C Shank Diameter	D Shank Length	E Overall Length	Stock*
85428M	BOS	3/8"	7/8"	3/8"	1¼"	3"	A

Router Bits - Edge Aligning

A-Line Edge Aligning Bit

Designed to precisely join all solid surfacing materials, hardwoods and other dense materials. Mating edges are aligned at precise level without changing router bit or router base. Unique trapezoidal design increases surface area for a stronger glue joint.

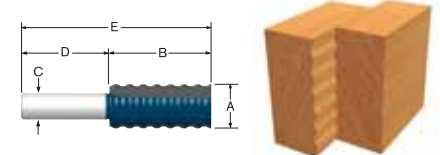

- Requires A-line sub-base #36010395054

Carbide Tipped

Item #	Code	A Cut Diameter	B Flute Length	C Shank Diameter	D Shank Length	E Overall Length	Stock*
85649M	BOS	7/8"	17/8"	½"	15/8"	3½"	A

*Y = stock item; A = readily available by order

Router Bits - Joinery

Rabbeting Bit

Micrograin control-cut bit for fast, smooth rabbeting cuts without the use of a router guide.

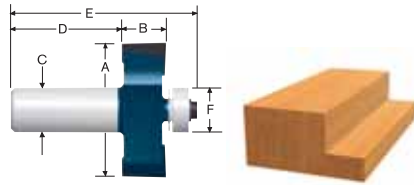

Carbide Tipped

Item #	Code	Rabbet Width	A Overall Dia.	B Cut Length	C Shank Dia.	D Shank Length	E Overall Length	F Bearing Dia.	Stock*
85218MC	BOS	3/8"	1 1/4"	1/2"	1/4"	1 1/4"	2 1/8"	1/2"	Y
85590M	BOS	3/8"	1 1/4"	1/2"	1/2"	1 1/2"	2 3/8"	1/2"	Y
85614	BOS	1/2"	1 1/2"	1/2"	1/4"	1 1/4"	2 1/8"	1/2"	A
85615MC	BOS	1/2"	1 1/2"	1/2"	1/2"	1 7/16"	2 3/8"	1/2"	A

Tongue and Groove Bit

Micrograin bit cuts tongue and grooves on 1/2" through 3/4" thick material. To cut the tongue, use complete assembly. To cut the groove, remove one slotting cutter. Cutters have 3-wing design.

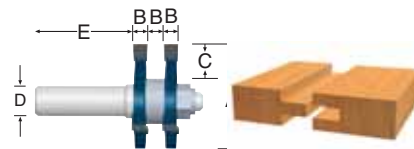

Carbide Tipped

Item #	Code	A Cut Dia.	B Flute Length	C Cutting Depth	D Shank Dia.	E Shank Len.	Replacement Item #	Stock*
84623M	BOS	1 7/8"	1/4"	1/2"	1/4"	1 1/4"	Cutter: 85610M Arbor: 84626	A
84624MC	BOS	1 7/8"	1/4"	1/2"	1/2"	1 1/2"	Cutter: 85610M Arbor: 82815	Y

Dovetail Bit

Micrograin bit for making dovetail joints.

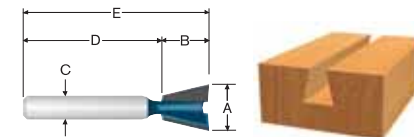

Carbide Tipped

Item #	Code	Degree	A Overall Dia.	B Flute Length	C Shank Dia.	D Shank Length	E Overall Length	Stock*
84700M	BOS	9	3/8"	3/8"	1/4"	1"	1 9/16"	A
84706M	BOS	9	3/8"	3/8"	1/2"	1 1/2"	2 1/8"	A
84709M	BOS	14	1/2"	1/2"	1/2"	1 1/2"	2 1/4"	A
84703MC	BOS	14	1/2"	1/2"	1/4"	1"	1 11/16"	Y
85240M	BOS	15	17/32"	1/2"	1/4"	1 3/8"	1 7/8"	A

Drawer Lock Joint Bit

Micrograin control-cut bit for constructing durable drawer joints.

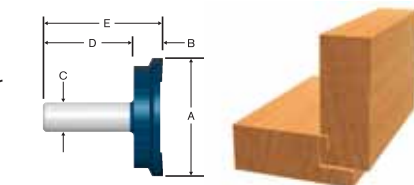

Carbide Tipped

Item #	Code	A Cut Diameter	B Flute Length	C Shank Diameter	D Shank Length	E Overall Length	Stock*
84512M	BOS	2"	1/2"	1/2"	1 1/2"	2"	A



Wedge Groove Bit

Micrograin control-cut bit for making groove style wedge cuts.

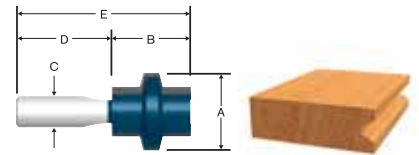

Carbide Tipped

Item #	Code	A Cut Diameter	B Flute Length	C Shank Diameter	D Shank Length	E Overall Length	Stock*
85510M	BOS	1 1/4"	1 1/4"	1/2"	1 1/2"	2 3/4"	A

Reversible Glue Joint Bit

Micrograin control-cut bit used for making glue-ups and strong joints in door panels, tabletops and more.

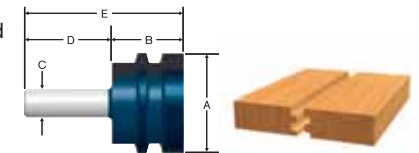

Carbide Tipped

Item #	Code	A Cut Diameter	B Flute Length	C Shank Diameter	D Shank Length	E Overall Length	Stock*
84505M	BOS	1 3/4"	1 1/4"	1/2"	1 1/2"	2 3/4"	A

Lock Miter Bit

Micrograin control-cut bit for making right angle joints and glue joints.

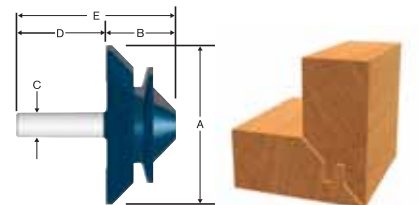

Carbide Tipped

Item #	Code	A Cut Diameter	B Flute Length	C Shank Diameter	D Shank Length	E Overall Length	Stock*
84508M	BOS	3 1/8"	1 3/8"	1/2"	1 3/4"	3 1/8"	A



*Y = stock item; A = readily available by order

Router Bits - Decorative Edge Forming



Roundover Bit

Micrograin bit used for smooth, uniformly rounded edges. Lower depth setting produces rounded corner with decorative bead.

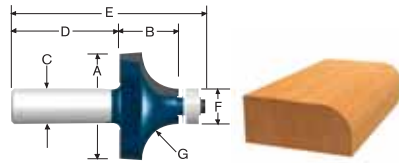

Carbide Tipped

Item #	Code	A Overall Dia.	B Flute Length	C Shank Dia.	D Shank Length	E Overall Length	F Bearing Dia.	G Cutting Radius	Stock*
85289M	BOS	13/16"	5/16"	1/4"	1 1/4"	1 7/8"	1/2"	1/16"	A
85587M	BOS	13/16"	5/16"	1/2"	1 1/2"	2 1/8"	1/2"	1/16"	A
85290MC	BOS	3/4"	5/16"	1/4"	1 1/4"	1 15/16"	1/2"	1/8"	Y
85588M	BOS	3/4"	5/16"	1/2"	1 1/2"	2 1/8"	1/2"	1/8"	A
85616M	BOS	13/16"	5/32"	1/4"	1 1/4"	1 7/8"	1/2"	5/32"	A
85293MC	BOS	7/8"	31/64"	1/4"	1 1/4"	2 1/8"	1/2"	3/16"	Y
84402M	BOS	7/8"	1/2"	1/2"	1 1/2"	2 1/4"	1/2"	3/16"	A
85294MC	BOS	1"	35/64"	1/4"	1 1/4"	2 3/16"	1/2"	1/4"	Y
84405M	BOS	1"	9/16"	1/2"	1 1/2"	2 5/16"	1/2"	1/4"	A
84408M	BOS	1 1/8"	9/16"	1/2"	1 1/2"	2 5/16"	1/2"	5/16"	A
85295MC	BOS	1 1/8"	37/64"	1/4"	1 1/4"	2 3/16"	1/2"	5/16"	Y
85296MC	BOS	1 1/4"	43/64"	1/4"	1 1/4"	2 3/8"	1/2"	3/8"	Y
85594M	BOS	1 1/4"	43/64"	1/2"	1 1/2"	2 5/8"	1/2"	3/8"	A
85297MC	BOS	1 1/2"	51/64"	1/4"	1 1/4"	2 7/16"	1/2"	1/2"	Y
85595MC	BOS	1 1/2"	51/64"	1/2"	1 1/2"	2 3/4"	1/2"	1/2"	Y
85596M	BOS	1 3/4"	15/16"	1/2"	1 1/2"	3"	1/2"	5/8"	A
85434MC	BOS	2"	1"	1/2"	1 1/2"	3"	1/2"	3/4"	A

Chamfer Bit

Micrograin control-cut bit for beveling and decorative edging.

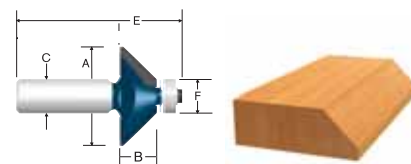

Carbide Tipped

Item #	Code	Degree	A Overall Dia.	B Flute Length	C Shank Dia.	E Overall Length	F Bearing Dia.	Stock*
85298MC	BOS	45	1 1/4"	1/2"	1/4"	2"	3/8"	Y
85299M	BOS	22.5	1 1/4"	15/16"	1/2"	2 7/8"	1/2"	A
85597MC	BOS	45	1 1/4"	1/2"	1/2"	2 3/8"	3/8"	A
85593M	BOS	45	2 1/2"	1"	1/2"	2 7/8"	1/2"	A

Roman Ogee Bit

Micrograin control-cut bit used for decorative edging and period furniture.

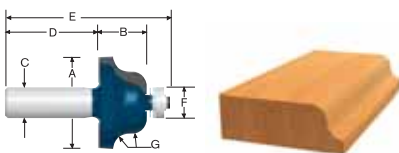

Carbide Tipped

Item #	Code	A Overall Dia.	B Flute Length	C Shank Dia.	D Shank Length	E Overall Length	F Bearing Dia.	G Cutting Radius	Stock*
85270MC	BOS	1 1/8"	1/2"	1/4"	1 1/4"	2 1/8"	1/2"	5/32"	Y
85591M	BOS	1 1/8"	1/2"	1/2"	1 1/2"	2 3/8"	1/2"	5/32"	A
85271MC	BOS	1 1/2"	3/4"	1/4"	1 1/4"	2"	1/2"	1/4"	Y
85592MC	BOS	1 1/2"	3/4"	1/2"	1 1/2"	2 1/16"	1/2"	1/4"	A

Beading Bit

Micrograin control-cut† bit is used to create attractive, decorative edging.

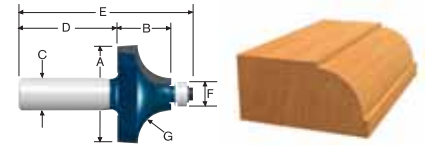

Carbide Tipped

Item #	Code	A Overall Dia.	B Flute Length	C Shank Dia.	D Shank Length	E Overall Length	F Bearing Dia.	G Cutting Radius	Stock*
85493MC	BOS	7/8"	31/64"	1/4"	1 1/4"	2 1/8"	3/8"	3/16"	A
84413M	BOS	7/8"	1/2"	1/2"	1 1/2"	2 1/8"	3/8"	3/16"	A
85494MC	BOS	1"	35/64"	1/4"	1 1/4"	2 5/32"	3/8"	1/4"	Y
84416M	BOS	1"	9/16"	1/2"	1 1/2"	2 13/32"	3/8"	1/4"	A
84419M	BOS	1 1/8"	9/16"	1/2"	1 1/2"	2 7/16"	3/8"	5/16"	A
85495M	BOS	1 1/8"	37/64"	1/4"	1 1/4"	2 3/16"	3/8"	5/16"	A
85496MC	BOS	1 1/4"	43/64"	1/4"	1 1/4"	2 9/16"	3/8"	3/8"	Y
85599M	BOS	1 1/4"	43/64"	1/2"	1 1/2"	2 5/16"	3/8"	3/8"	A
85497M	BOS	1 1/2"	51/64"	1/4"	1 1/4"	2 7/16"	3/8"	1/2"	A
85600M	BOS	1 1/2"	51/64"	1/2"	1 1/2"	2 11/16"	3/8"	1/2"	A

†#84413M and #85493M are not control-cut bits.

Ogee Bit w/Fillet

Micrograin control-cut bit produces three different cuts. Graceful lines of the ogee cut can be attractively accented by one or two fillets by lowering depth setting or using 3/8" diameter bearing.

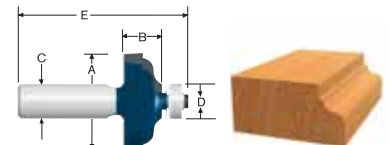

Carbide Tipped

Item #	Code	A Overall Diameter	B Flute Length	C Shank Diameter	D Bearing Diameter	E Overall Length	Stock*
85584M	BOS	1 3/8"	9/16"	1/4"	1/2"	2 3/16"	A
85586M	BOS	1 5/8"	5/8"	1/2"	1/2"	2 1/2"	A

Cove Bit

Micrograin control-cut bit for decorative edging and period furniture.

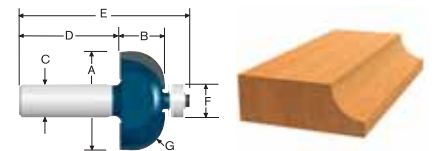

Carbide Tipped

Item #	Code	A Overall Dia.	B Flute Length	C Shank Dia.	D Shank Length	E Overall Length	F Bearing Dia.	G Cutting Radius	Stock*
85205MC	BOS	1"	1/2"	1/4"	1 1/4"	2 1/8"	1/2"	1/4"	A
84425M	BOS	1"	1/2"	1/2"	1 1/2"	2 1/8"	1/2"	1/4"	A
85206MC	BOS	1 1/4"	9/16"	1/4"	1 1/4"	2 13/64"	1/2"	3/8"	A
84428M	BOS	1 1/4"	9/16"	1/2"	1 1/2"	2 5/16"	1/2"	3/8"	A
85207MC	BOS	1 1/2"	5/8"	1/4"	1 1/4"	2 11/32"	1/2"	1/2"	Y
84431M	BOS	1 1/2"	11/16"	1/2"	1 1/4"	2 3/8"	1/2"	1/2"	A

*Y = stock item; A = readily available by order

Router Bits - Decorative Edge Forming

Classical Bit

Micrograin control-cut bit adds classic beauty with decorative edging.

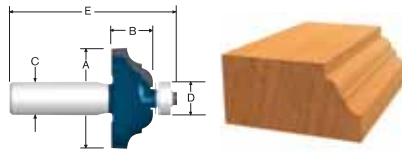

Carbide Tipped

Item #	Code	A Overall Diameter	B Flute Length	C Shank Diameter	D Bearing Diameter	E Overall Length	Stock*
85579M	BOS	1 1/4"	1/2"	1/4"	1/2"	2 1/4"	A
85580M	BOS	1 1/4"	1/2"	1/2"	1/2"	2 7/16"	A
85581MC	BOS	1 1/2"	5/8"	1/4"	1/2"	2 1/4"	A
85582M	BOS	1 1/2"	5/8"	1/2"	1/2"	2 11/16"	A

Edge Beading Bit

Versatile bit adds attractive edging on new pieces and matches many older molding cuts for remodeling work.

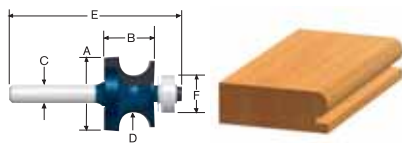

Carbide Tipped

Item #	Code	A Overall Dia.	B Flute Length	C Shank Dia.	D Cutting Radius	E Overall Length	F Bearing Dia.	Stock*
85631M	BOS	7/8"	17/32"	1/4"	1/8"	2 5/32"	1/2"	A
85632M	BOS	7/8"	17/32"	1/2"	1/8"	2 1/2"	1/2"	A
85666M	BOS	1"	1 1/16"	1/4"	3/16"	2 11/32"	1/2"	Y
85668MC	BOS	1 1/4"	7/8"	1/4"	1/4"	2 1/2"	5/8"	A
85669M	BOS	1 1/4"	7/8"	1/2"	1/4"	2 1/2"	5/8"	A

Cove and Bead Bit

Micrograin bit creates a classic woodworking design that adds an attractive accent to any design.

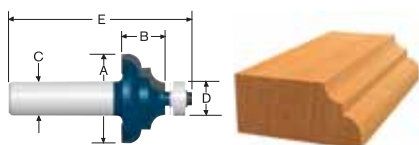

Carbide Tipped

Item #	Code	A Overall Diameter	B Flute Length	C Shank Diameter	D Bearing Diameter	E Overall Length	Stock*
85604MC	BOS	1 5/16"	5/8"	1/4"	1/2"	2 1/4"	Y
85605M	BOS	1 5/16"	5/8"	1/2"	1/2"	2 1/2"	A

Wavy Edge Bit

Micrograin bit with a unique pattern to create soft, rounded corners.

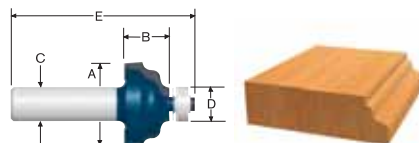

Carbide Tipped

Item #	Code	A Overall Diameter	B Flute Length	C Shank Diameter	D Bearing Diameter	E Overall Length	Stock*
85606M	BOS	1 1/4"	1 1/16"	1/4"	1/2"	2 1/4"	A
85607M	BOS	1 1/4"	1 1/16"	1/2"	1/2"	1 1/2"	A

Multi-Bead/Reeding Bit

Micrograin control-cut bit creates classic triple beading with fillet pattern in one pass.

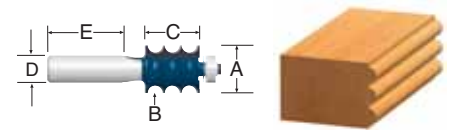

Carbide Tipped

Item #	Code	A Overall Diameter	B Cutting Radius	C Flute Length	D Shank Diameter	E Shank Length	Stock*
84611M	BOS	7/8"	1/8"	1"	1/2"	1 3/4"	A

Bullnose Bit

Micrograin bit used for window sills, shelves or stair treads.

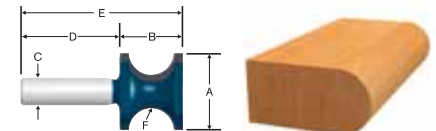

Carbide Tipped

Item #	Code	A Overall Dia.	B Flute Length	C Shank Dia.	D Shank Length	E Overall Length	F Cutting Radius	Stock*
84432M	BOS	5/8"	1 1/8"	1/2"	1 1/2"	2"	1/8"	A
84433M	BOS	1"	9/16"	1/2"	1 3/4"	2 7/16"	1/4"	A
84434M	BOS	1 3/8"	1 1/4"	1/2"	1 3/4"	2 7/8"	3/8"	Y
84435M	BOS	1 7/8"	5/8"	1/4"	1 1/4"	1 7/8"	3/16"	A
84436M	BOS	3 5/16"	1 1/2"	1/2"	1 3/4"	3 5/16"	1/2"	A

Multi-Form Bit

Micrograin bit achieves 50 different moulding patterns with simple adjustment to cutter height and fence.

- Not for use in hand-held routers; use with router table only

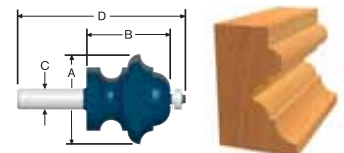

Carbide Tipped

Item #	Code	A Overall Diameter	B Flute Length	C Shank Diameter	D Overall Length	Stock*
85700M	BOS	1 1/32"	2"	1/2"	4"	A

Plunge Roundover Bit

Micrograin control-cut bit for special decorative grooving and edging.

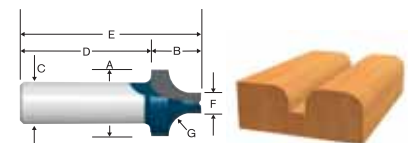

Carbide Tipped

Item #	Code	A Overall Dia.	B Flute Length	C Shank Dia.	D Shank Length	E Overall Length	F Pilot Dia.	G Cutting Radius	Stock*
85471M	BOS	3/4"	3/5"	1/2"	1 1/2"	1 1/8"	1/4"	1/4"	A

*Y = stock item; A = readily available by order

Router Bits - Decorative Edge Forming

Reverse Curve Ogee and Bead Bit

Micrograin bit is a classic architectural moulding bit used to make furniture and cabinet moulding, door and window casing and other millwork.

- Not for use in hand-held routers; use with router table only

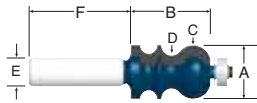

Carbide Tipped

Item #	Code	A Cut Dia.	B Flute Length	C Large Radius	D Small Radius	E Shank Dia.	F Shank Length	Stock*
84620M	BOS	1 ⁵ / ₁₆ "	1 ³ / ₈ "	5 ⁵ / ₁₆ "	1 ¹ / ₆₄ "	1/2"	1 ³ / ₄ "	A

Ogee and Bead Bit with Fillet

Micrograin bit is a classic architectural moulding bit used to make furniture and cabinet moulding, door and window casing and other millwork.

- Not for use in hand-held routers; use with router table only

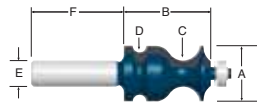

Carbide Tipped

Item #	Code	A Cut Dia.	B Flute Length	C Large Radius	D Small Radius	E Shank Dia.	F Shank Length	Stock*
84621M	BOS	1 ¹ / ₁₆ "	1 ⁵ / ₈ "	5 ⁵ / ₁₆ "	1/8"	1/2"	2 ¹ / ₈ "	A

Chair Mat Bit

Micrograin control-cut bit cuts out and edge forms chair mats and other items fabricated from softer plastic, such as vinyl and acrylic, in a single operation. Bit is specially shaped to help minimize edge cracking in these materials and can also be used for 1/4" and thinner wood and plywood.

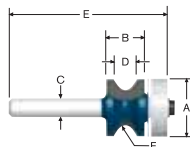

Carbide Tipped

Item #	Code	A Overall Dia.	B Flute Length	C Shank Dia.	D Cutter Opening	E Overall Length	F Radius	Stock*
85612M	BOS	19 mm	1 ⁵ / ₃₂ "	1/4"	9 ⁹ / ₃₂ "	2 ¹¹ / ₃₂ "	3 ³ / ₃₂ "	A

Router Bits - Solid Surface

Bevel Bowl Bit

Micrograin bit for use when fabricating solid undermount bowls.

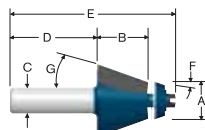

*Y = stock item; A = readily available by order

Cove and Bead Large Bit

- Classic architectural moulding bit. Use to make furniture and cabinet moulding, door and window casing and other millwork.
- Not for use in hand-held routers; use with router table only.



Carbide Tipped

Item #	Code	A Cut Dia.	B Flute Length	C Large Radius	D Small Radius	E Shank Dia.	F Shank Length	Stock*
85612M	BOS	1 ⁵ / ₁₆ "	1 ³ / ₈ "	3/4"	9 ⁹ / ₆₄ "	1/2"	1 ³ / ₄ "	A

Traditional Bit

- Classic architectural moulding bit. Use to make furniture and cabinet moulding, door and window casing and other millwork.
- Not for use in hand-held routers; use with router table only.

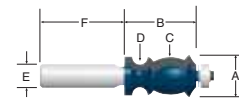

Carbide Tipped

Item #	Code	A Cut Dia.	B Flute Length	C Large Radius	D Small Radius	E Shank Dia.	F Shank Length	Stock*
85622M	BOS	1 ⁵ / ₁₆ "	1 ¹ / ₂ "	3/4"	5 ⁵ / ₃₂ "	1/2"	1 ³ / ₄ "	A



Router Bits - Decorative Surface Forming



Core Box Bit

Micrograin bit cuts rounded grooves used in a variety of applications, including doors and columns.

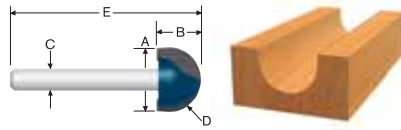

Carbide Tipped

Item #	Code	A Overall Diameter	B Flute Length	C Shank Diameter	D Radius	E Overall Length	Stock*
85444M	BOS	1/4"	3/8"	1/4"	1/8"	2"	A
84445M	BOS	3/8"	5/16"	1/4"	3/16"	1 5/16"	Y
85446M	BOS	1/2"	3/8"	1/4"	1/4"	2"	Y
85447M	BOS	5/8"	7/16"	1/4"	5/16"	2 1/8"	A
85448M	BOS	3/4"	1/2"	1/4"	3/8"	2 1/8"	Y

Core Box Bit - Two Flutes

Deeper cut round nose bit cuts rounded grooves used in a variety of applications, including doors and columns.

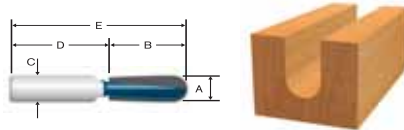

Carbide Tipped

Item #	Code	A Overall Diameter	B Flute Length	C Shank Diameter	D Shank Length	E Overall Length	Stock*
85449M	BOS	1/2"	1 1/4"	1/2"	1 5/8"	2 7/8"	A
85450M	BOS	3/4"	1 1/4"	1/2"	1 1/2"	2 3/4"	A
85451M†	BOS	1"	1 1/4"	1/2"	1 1/2"	2 3/4"	A

†Control-cut bit

Classical Bit

Micrograin bit is used for beautiful, decorative grooving, adding a quality accent to any product. Also recommended for edge forming with a router guide.

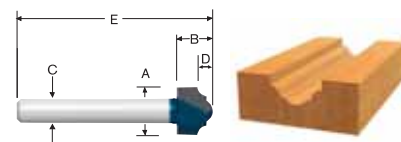

Carbide Tipped

Item #	Code	A Overall Dia.	B Flute Length	C Shank Dia.	D Decorative Cut Depth	E Overall Length	Stock*
85467M	BOS	1/2"	3/8"	1/4"	5/32"	2"	A
85468M	BOS	3/4"	1/2"	1/4"	5/32"	2 1/8"	A

Veining Bit

Provincial design veining bit for recessed design veining in fine cabinet surfaces. Used extensively for door front grooving.

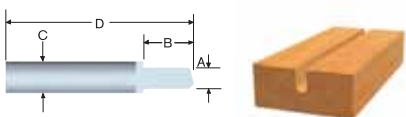

Solid Carbide

Item #	Code	A Cut Diameter	B Flute Length	C Shank Diameter	D Overall Length	Stock*
85283	BOS	1/4"	3/8"	1/4"	1 5/8"	A

V-Groove and Scoring Bit - Double Flute

Micrograin bit is ideal for door-front grooving, lettering and sign work. Features sheer angle cutter geometry for smooth, efficient cutting.

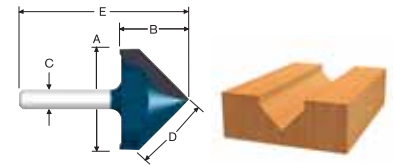

Carbide Tipped

Item #	Code	A Overall Diameter	B Flute Length	C Shank Diameter	D Bevel Cut	E Overall Length	Stock*
84300M	BOS	3/8"	5/8"	1/4"	1/4" (45°)	1 9/16"	A
85219MC	BOS	9/16"	1 3/16"	1/4"	3/8" (45°)	1 3/4"	Y
84303M	BOS	5/8"	7/16"	1/2"	7/16" (45°)	1 15/16"	A
84306M	BOS	3/4"	1/2"	1/2"	19/32" (45°)	2"	A
84309M	BOS	1"	3/4"	1/2"	13/16" (45°)	2 3/8"	A
85220M	BOS	1 1/4"	7/8"	1/4"	7/8" (45°)	2 1/16"	A

V-Groove and Scoring Bit - Single Flute

For grooving and scoring panel design in wood surfaces. Produces simulated paneling for walls, doors and furniture.

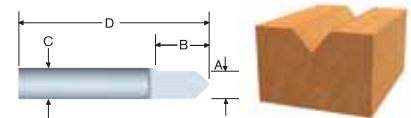

Solid Carbide

Item #	Code	A Overall Diameter	B Flute Length	C Shank Diameter	D Bevel Cut	E Overall Length	Stock*
85284	BOS	1/4"	3/8"	1/4"	41°	1 5/8"	A

60° Lettering Bit

- High quality lettering in wooden signs.
- Control cut bits.

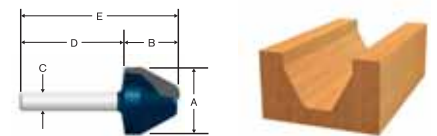

Carbide Tipped

Item #	Code	A Overall Diameter	B Flute Length	C Shank Diameter	D Bevel Cut	E Overall Length	Stock*
85621M	BOS	1"	3/4"	1/4"	1 1/2"	2 1/4"	A

*Y = stock item; A = readily available by order

Router Bits – Cabinetry

Face Frame/Flush Trim V-Groove Bit

Micrograin bit is used to flush-face frame to cabinet side and, at the same time, cut V-groove down joint of cabinet. Also used for creating a decorative V-groove cut.

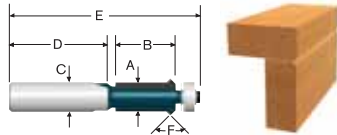

Carbide Tipped

Item #	Code	A Cut Dia.	B Flute Length	C Shank Dia.	D Shank Length	E Overall Length	Angle	Stock*
85646M	BOS	1/2"	1"	1/4"	1 1/4"	2 5/8"	90°	A
85647M	BOS	1/2"	1"	1/2"	1 5/8"	3 5/8"	90°	A

Doorlip Bit

Micrograin bit achieves a quality doorlip cut with a router.

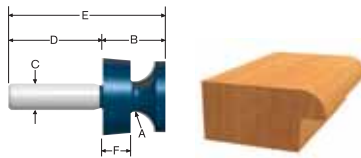

Carbide Tipped

Item #	Code	A Radius	B Flute Length	C Shank Dia.	D Shank Length	E Overall Length	F Rabbet Depth	Stock*
85646M	BOS	3/8"	1 3/32"	1/2"	1 5/8"	2 3/4"	7/16"	A

Finger Pull Bit

Micrograin control-cut bit creates easy-open door or drawer edge that eliminates metal pulls and enhances hardwood effect.

- Not for use in hand-held routers; use with router table only

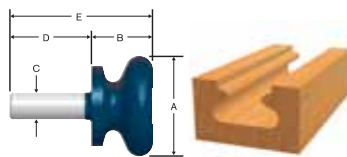

Carbide Tipped

Item #	Code	A Overall Diameter	B Flute Length	C Shank Diameter	D Bevel Cut	E Overall Length	Stock*
84540M	BOS	1 7/8"	1 1/8"	1/2"	1 1/2"	2 5/8"	A

Drawer Lock Joint Bit

Micrograin control-cut bit for constructing durable drawer joints.

- Not for use in hand-held routers; use with router table only

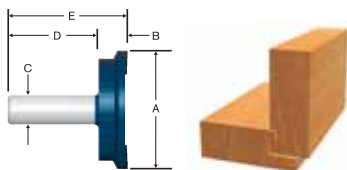

Carbide Tipped

Item #	Code	A Overall Diameter	B Flute Length	C Shank Diameter	D Bevel Cut	E Overall Length	Stock*
84512M	BOS	2"	1/2"	1/2"	1 1/2"	2"	A

Beading Stile and Rail Bit

Micrograin bit with shear angle geometry, super-sharp cutting edges and close tolerance manufacturing to ensure consistently smooth, tight-fitting joints.

- Designed for 3/4" wood with a maximum wood thickness 7/8"
- Recommended for use with a router table; not for use with hand-held routers

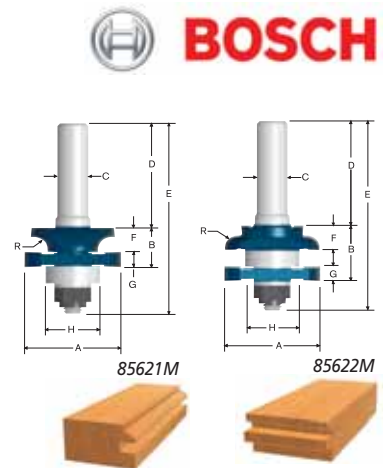

Carbide Tipped

Item #	Code	A	B	C	D	E	F	G	H	R	Stock*
85621M†	BOS	1 5/8"	5/8"	1/2"	1 5/8"	3"	3/8"	1/4"	7/8"	7/32"	A
85622M	BOS	1 5/8"	7/8"	1/2"	1 5/8"	3"	3/8"	1/4"	7/8"	7/32"	A

†Control cut bit

Ogee Beading Stile and Rail Bit

Micrograin bit with shear angle geometry, super-sharp cutting edges and close-tolerance manufacturing to ensure consistently smooth, tight-fitting joints.

Assemblies are reversible. Can be used to make both stile and rail cuts by reassembling the cutters in a different order on the arbor. This requires one workpiece to be cut face up and the other workpiece to be cut face down.

- Designed for 3/4" wood with a maximum wood thickness 7/8"
- Recommended for use with a router table; not for use with hand-held routers

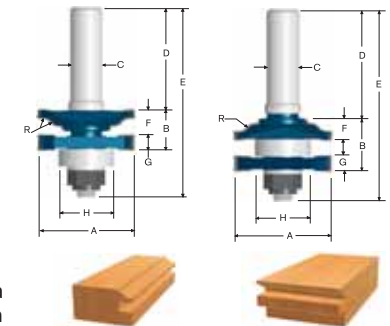

Carbide Tipped

Item #	Code	A	B	C	D	E	F	G	H	R	Stock*
85626M	BOS	1 5/8"	2 1/32"	1/2"	1 5/8"	3"	13/32"	3/32"	7/8"	5/32"	A
85627M	BOS	1 5/8"	3/4"	1/2"	1 5/8"	3"	17/64"	1/4"	7/8"	5/32"	A

Key Hole Bit

For plunge and slot cuts. Route mounting slots in picture frames and plaques.

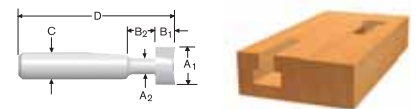

Carbide Tipped

Item #	Code	A1 Diameter	A2 Diameter	B Cutting Edge	C Shank Diameter	D Overall Length	Stock*
85608MC	BOS	3/8"	3/16"	3/16"	1/4"	1 7/8"	Y

*Y = stock item; A = readily available by order

Router Bits - Cabinetry

Ogee Vertical Panel Raiser Bit

Micrograin bit used to create beautiful shadow lines for cabinet doors.

- Minimum recommended panel thickness is 3/4"
- Not for use in hand-held routers; use with router table only

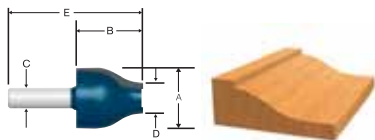

Carbide Tipped

Item #	Code	A Cut Diameter	B Flute Length	C Shank Diameter	D Overall Length	Stock*
85712M	BOS	1 1/2"	1 5/8"	1/2"	3 1/4"	A

Cove Vertical Panel Raiser Bit

Micrograin bit with a long, swooping radius (1/4"-2 1/2") for beautiful panels.

- Minimum recommended panel thickness is 3/4"
- Not for use in hand-held routers; use with router table only

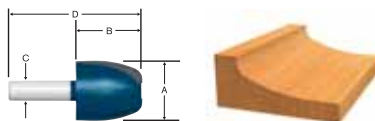

Carbide Tipped

Item #	Code	A Cut Diameter	B Flute Length	C Shank Diameter	D Overall Length	Stock*
85708M	BOS	1 1/2"	1 5/8"	1/2"	3 1/4"	A

Raised Panel Bit - Ball Bearing Pilot

Micrograin control-cut bit creates clean, simple lines to accentuate a surface.

- Minimum recommended panel thickness is 3/4"
- Not for use in hand-held routers; use with router table only

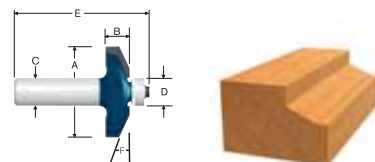

Carbide Tipped

Item #	Code	A Overall Dia.	B Flute Length	C Shank Dia.	D Bearing Dia.	E Overall Length	F Angle	Stock*
85583M	BOS	1 5/8"	7/16"	1/2"	1/2"	2 7/16"	25°	A

Raised Panel Cutters

Micrograin bit produces raised panel cuts along straight and curved panel edges.

- Minimum recommended panel thickness is 3/4"
- Not for use in hand-held routers; use with router table only

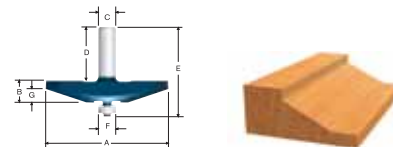

Carbide Tipped

Item #	Code	Cutting Width	A	B	C	D	E	F	G	Degree	Stock*
85637M	BOS	1 1/8"	2 3/4"	5/8"	1/2"	1 1/2"	2 15/32"	1/2"	3/8"	26°	A
85639M	BOS	1 1/2"	3 1/2"	5/8"	1/2"	1 1/2"	2 15/32"	1/2"	3/8"	18°	A

Ogee Raised Panel Cutters

Micrograin bit produces raised panel cuts along straight and curved panel edges.

- Minimum recommended panel thickness is 3/4"
- Not for use in hand-held routers; use with router table only

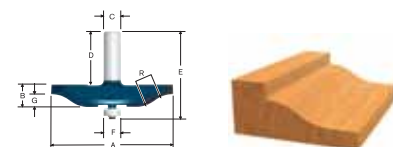

Carbide Tipped

Item #	Code	Cutting Width	A	B	C	D	E	F	G	R	Stock*
85638M	BOS	1 1/8"	2 3/4"	5/8"	1/2"	1 1/2"	2 15/32"	1/2"	3/8"	7/16"	A
85640MC	BOS	1 1/2"	3 1/2"	5/8"	1/2"	1 1/2"	2 15/32"	1/2"	3/8"	7/8"	A

SEE OUR RENTAL DEPARTMENT OR WEB SITE FOR INFORMATION ON RENTING SAWS



*Y = stock item; A = readily available by order



Router Bits - Slotting Cutters & Arbors

Two-Wing Slotting Cutter

Micrograin control-cut bit used to make slots for T-molding and weather stripping.

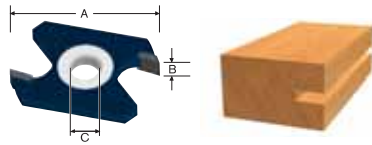

Item #	Code	A Cutter Diameter	B Kerf	C Arbor Diameter	D Depth of Cut	Stock*
85505M	BOS	1 3/16"	1/4"	1/4"	9/32"	A

Three-Wing Slotting Cutter

Micrograin control-cut bit used to make slots for T-molding and weather stripping.

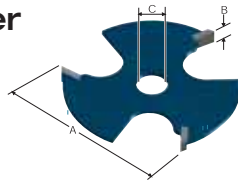

Item #	Code	A Cutter Diameter	B Kerf	C Arbor Diameter	D Depth of Cut	Stock*
85526M	BOS	1 7/8"	1/16"	5/16"	1/2"	Y
85527M	BOS	1 7/8"	5/64"	5/16"	1/2"	A
85528M	BOS	1 7/8"	3/32"	5/16"	1/2"	A
85529M	BOS	1 7/8"	1/8"	5/16"	1/2"	A
85609M	BOS	1 7/8"	3/16"	5/16"	1/2"	A
85610MC	BOS	1 7/8"	1/4"	5/16"	1/2"	Y

Arbor for Slotting Cutter



Arbor Selection for Two-Wing Slotting Cutters

Item #	Code	Shank Dia.	Arbor Dia.	Length	Ball Bearing Dia.	Fits Slotting Cutters	Stock*
82808	BOS	1/4"	1/4"	1 29/32"	5/8"	85505M, 85506M, 85507M, 85508M	A
82810	BOS	1/4"	5/16"	2 5/8"	7/8"	85517M, 85520M, 92837	Y

Arbor Selection for Three-Wing Slotting Cutters

Item #	Code	Shank Dia.	Arbor Dia.	Length	Ball Bearing Dia.	Fits Slotting Cutters	Stock*
92813	BOS	1/4"	5/16"	2"	-	All	A
82811C	BOS	1/2"	5/16"	3"	7/8"	All	Y

*Y = stock item; A = readily available by order

Router Bits - Components

Bearing Enlarger

For changing profiles, widths and rabbeting depth of ball bearing-piloted router bits with 3/16" O.D. pilots.

Item #	Code	Outside Diameter	Inside Diameter	Stock*
BE006	BOS	3/4"	3/16"	A
BE007	BOS	7/8"	3/16"	A
BE008	BOS	1"	3/16"	A
BE009	BOS	1 1/8"	3/16"	A
BE400	BOS	Complete Set of BE006, BE007, BE008 7 BE009		A



Nonmarring Bearing

Specially engineered, high precision bearings are fitted with nonmarring nylon sleeves to prevent scratching on all surfaces. Use with piloted router bits, including laminate trim and edge forming bits.

Item #	Code	Outside Diameter	Inside Diameter	Stock*
NMB004	BOS	1/2"	3/16"	A
NMB005	BOS	5/8"	1/4"	A
NMB006	BOS	3/4"	1/4"	A
NMB300	BOS	Complete Set of NMB004, NMB005, NMB006		A



Benchtop Router Table

- Precision machined 27" x 18" aluminum work surface
- 4 1/2" x 25 1/2" aluminum fence with adjustable MDF face plates; outfeed can be offset for jointing
- Dust collection port for standard 2 1/2" vacuum hoses
- 14 1/2" x 18" x 27" (H x D X W)
- Maximum fence opening: 3 3/16"
- Maximum throat opening: 3 3/8"
- Cord length: 6'
- Includes (2) Adjustable Featherboards, (3) Mounting Plate Insert Rings, Adjustable Clear Guard, Starter Pin Guard, (2) Outfeed Fence Shims and Mounting Hardware

Item #	Code	Description	Stock*
RA1181	BOS	Benchtop Router Table	A

Band Saw Blades

MORSE



Master Cobalt® Bi-Metal Portable Band Saw Blade

High-speed steel is electron beam welded to a flexible backer to create longer lasting, faster cutting blades resistant to the effects of shock and heat. Variable pitch teeth reduce vibration. Use on machinable metals, including stainless steel, pipe, tubing and solids. Blades fit all portable band saw machines.

Item #	Code	Length x Width x Thickness (inches)	Teeth Per Inch	Set	Stock*
ZWEPXTL441014	MOR	44 ⁷ / ₈ x 1/2 x .020	10/14	Wavy	Y
ZWEPXTL441418	MOR	44 ⁷ / ₈ x 1/2 x .020	14/18	Wavy	Y
ZWEPXTL442024	MOR	44 ⁷ / ₈ x 1/2 x .020	20/24	Wavy	Y

High Carbon Steel Band Saw Blade

Item #	Code	Size	Teeth Per Inch	Set	Stock*
ZHBFR08-HVB7M	MOR	7'9" x 3/4" x .032	8	Raker	Y
ZHBFR14-HVB7M	MOR	7'9" x 3/4" x .032	14	Raker	Y

Bi-Metal Band Saw Blade

Item #	Code	Size	Teeth Per Inch	Set	Stock*
1634100644	MOR	64.5" x 1/2" x .025	10	Raker	Y
1634140644	MOR	64.5" x 1/2" x .025	14	Raker	Y
1634240644	MOR	64.5" x 1/2" x .025	24	Raker	Y

DELTA

High carbon steel blades with precision machined and set teeth for accuracy. Tension-tested for strength.

Item #	Code	Width	Min. Cut	TPI	Thick	Application	Stock*
28-165	DEL	1/4"	3/4"	6	.014"	8" Bench Band Saw (56 ¹ / ₈): General purpose cutting of woods, plastics and compositions.	Y
28-167	DEL	1/8"	3/8"	14	.014"		A
28-168	DEL	3/8"	1"	6	.014"		A
28-032	DEL	1/8"	3/16"	14	.020"	14" Band Saw (93 ¹ / ₂) General purpose cutting of woods, plastics and compositions, nonferrous metals, including aluminum.	Y
28-033	DEL	3/16"	5/16"	6	.020"		Y
28-034	DEL	1/4"	5/8"	6	.020"		Y
28-036	DEL	3/8"	1 3/8"	6	.020"		Y
28-038	DEL	1/2"	2 1/2"	6	.020"		Y
28-040	DEL	3/4"	3"	4	.020"		A
28-060	DEL	1/2"	2 1/2"	14	.025"		Hard tooth, flex back general purpose blades for ferrous and nonferrous metal cutting.
28-062	DEL	1/2"	2 1/2"	18	.025"	Y	
28-064	DEL	1/2"	2 1/2"	24	.025"	A	

LENOX

Master-Band® Premium Portable Band Saw Blade

Specially treated band of .023 thick offset increased blade strength, reducing blade deflection and twist. Bi-metal blade resists breaking and extends blade life.

- Length x Width x Thickness: 3' 8⁷/₈" x 1/2" x .023



Item #	Code	Teeth Per Inch	Applications	Stock*
38EW10/14	LEN	10/14	1/4" & larger	A
38EW14	LEN	14	3/16" - 3/8"	Y
38EW18	LEN	18	3/32" - 1/4"	Y

Milwaukee

Standard/Deep Cut Portable Band Saw Blade

Matrix II high speed steel teeth have long tooth life and deliver exceptional durability in metal-cutting applications, including strut, conduit, angle iron, copper tube, threaded rod and pipe.

- Designed for portable band saws using 44⁷/₈" blades



Item #	Code	Diameter or Wall Thickness	Teeth Per Inch	Stock*
48-39-0500	MIL	5/16" and up	10	Y
48-39-0510	MIL	3/16" - 5/16"	14	Y
48-39-0520	MIL	5/32" - 3/16"	18	Y
48-39-0530	MIL	Up to 5/32"	24	Y

Bi-Metal Portable Band Saw Blade

- Cuts metal, wood and plastic
- 3-blade pack



Item #	Code	Length x Width x Thickness	Teeth Per Inch	Stock*
CBS2810	BOS	28 ⁷ / ₈ " x 1/2" x .02"	10	Y
CBS2814	BOS	28 ⁷ / ₈ " x 1/2" x .02"	14	Y
CBS2818	BOS	28 ⁷ / ₈ " x 1/2" x .02"	18	Y
CBS2824	BOS	28 ⁷ / ₈ " x 1/2" x .02"	24	Y

Planer Blades



Item #	Code	Fits Model	Description	Stock*
22-547	DEL	TP300 & 22-540 12" Portable Planers	Set of two high-speed steel, 12" knives. Double-edged & reversible.	Y
22-562	DEL	TP400LS, 22-565 & 22-560 12½" Portable Planers	Set of two high-speed, 12½" knives. Double-edged & reversible.	Y
22-549	DEL	22-580 13" Portable Planer	Knives.	A
22-129	DEL	22-401 13" x 6" & 22-101 13" x 5" Planers	Set of three knives.	A
22-656	DEL	13" Planer	Set of three high-speed steel knives.	Y
22-677	DEL	22-680 DC-380 15" Planer	Set of three high-speed steel, 15" knives.	A
22-452	DEL	22-450 & 22-451 DC-58020" Planers	Set of three knives.	A
22-606	DEL	22-610 RC-63D/ Newman 24" Planer	Set of four high-speed steel, 24" knives.	A
22-609	DEL	22-470 24" Planer	Set of three high-speed steel, 24" knives.	A



Planer Knives

Item #	Code	Fits Model	Description	Stock*
708807	JET	Jet 15" Planer	JWP-15H0 Knives	Y
708813	JET	Jet 12½" Planer	JWP-12-4P Double-edged Knives	A

Micrograin Carbide Tungsten Blades

- Double edge, reversible
- Fits Bosch and most competitive planers



Item #	Code	Description	Stock*
PA1202	BOS	Carbide Tungsten Planer Blades - 2 blades/pack	Y

Reciprocating Blades

Diablo Carbide-Tipped Reciprocating Saw Blade for Wood & Nail Embedded Wood



Item #	Code	Length	TPI	Stock*
DS0606CW	FRE	6"	6	Y
DS0906CW	FRE	9"	6	Y
DS1206CW	FRE	12"	6	Y



Diamond® Recip Blades

- Nickel alloy-brazed diamond particles maintain sharpness to last three times longer
- Narrow kerf design enables thinner, faster cuts
- Cuts cast iron, tile, brick and architectural stone
- One blade per pack



Item #	Code	Length x Width x Thickness (inches)	Stock*
10833	LEN	8 x ¾ x .040	Y

Master-Grit® Recip Blades

- Tungsten carbide, medium grit edge
- Specially designed for cutting tough abrasives, such as cast iron, fiberglass, ceramic wall tile, clay pipe, stone, brick, plaster and marble
- Two blades per pack



Item #	Code	Length x Width x Thickness (inches)	Stock*
600RG	LEN	6 x ¾ x .032	Y
800RG	LEN	8 x ¾ x .040	Y
20506-100RG	LEN	10 x ¾ x .050	A



Gold® Recip Blades

- Reinforced tooth design and precision applied titanium coating dissipate heat
- Bi-metal design
- Five blades per pack

Item #	Code	Length x Width x Thickness (inches)	Teeth Per Inch	Application	Stock*
21060	LEN	6 x ¾ x .050	6	Wood	Y
21062	LEN	12 x ¾ x .050	6	Wood	Y
21067	LEN	9 x ¾ x .050	14	Metal	Y
21069	LEN	6 x 7/16 x .050	18	Metal	Y
21070	LEN	6 x ¾ x .035	18	Metal	Y

*Y = stock item; A = readily available by order

Reciprocating Blades



Item #	Code	Length x Width x Thickness (inches)	Teeth Per Inch	Qty. Per Pack†	Stock*	Application
656R	LEN	6 x 3/4 x .050	6	5	Y	Roughing-in work & nail-embedded wood. Fast cutting. Pipe, structural steel, stainless steel, nonferrous metal: 3/16" & thicker.
156R	LEN	12 x 3/4 x .050	6	5	Y	
956R	LEN	9 x 3/4 x .050	6	5	Y	
676RC	LEN	6 x 7/16 x .050	6	5	Y	Contour cutting in all wood, nail-embedded wood & composition materials.
606R	LEN	6 x 3/4 x .035	6	5	Y	Fast cutting for wood, composition materials, plastics & nonferrous metal.
634R	LEN	6 x 3/4 x .050	4	5	Y	Extra fast cutting in thick, nail-free wood.
610R	LEN	6 x 3/4 x .035	10**	5	Y	Nail-embedded wood, composition materials & plastic. Pipe, carbon steel & stainless steel: 3/8" - 1/4" thick. Nonferrous metal: 1/8" - 1/2" thick.
810R	LEN	8 x 3/4 x .050	10**	5	Y	
110R	LEN	12 x 3/4 x .050	10/14**	5	Y	
20520-314RC	LEN	3 5/8 x 5/16	14**	5	A	
20550-414R	LEN	4 x 3/4 x .035	14**	5	A	Pipe, structural steel, stainless steel: 3/32" - 1/4" thick. Nonferrous metal: 3/32" - 3/8". Hard rubber.
614R**	LEN	6 x 3/4 x .035	14**	5	Y	
418R**	LEN	4 x 3/4 x .035	18**	5	Y	Structural steel, pipe, conduit, stainless steel: 1/16" - 9/16" thick. Nonferrous metal: 1/16" - 5/16" thick.
618R**	LEN	6 x 3/4 x .035	18**	5	Y	
818R**	LEN	8 x 3/4 x .035	18**	5	Y	
20510-118R	LEN	12 x 3/4 x .035	18**	5	A	
318RC**	LEN	3 5/8 x 5/16 x .035	18**	5	Y	Contour cutting in metal: 1/16" - 1/8" thick.
20554-424R	LEN	4 x 3/4 x .035	24**	5	A	All metals less than 1/8" thick. Tubing, conduit & trim.
624R**	LEN	6 x 3/4 x .035	24**	5	Y	
20579-824R	LEN	8 x 3/4 x .035	24**	5	A	For plaster, plaster board and lath. Bi-directional cutting.
20449-456RP	LEN	4 x 3/4 x .050	6	5	A	
636RP	LEN	6 x 3/4 x .050	6	5	Y	
6066R	LEN	6 x 7/8 x .062	6	2	Y	
966R	LEN	9 x 7/8 x .062	6	2	Y	Demolition work in nail-embedded wood.
960R**	LEN	9 x 7/8 x .062	10**	2	Y	
20500-106R	LEN	12 x 7/8 x .062	6	2	A	Demolition work in wood and metal. Fire and rescue.
650R	LEN	6 x 3/4 x .050	10/14	2	Y	
20577-850R	LEN	8 x 3/4 x .050	10/14	5	A	Heavy-duty. Extended life when cutting pipe, structural steel and stainless steel. Fire and rescue.
20593-6514R	LEN	6 x 3/4 x .050	14**	2	A	
20594-6518R	LEN	6 x 3/4 x .050	18**	2	A	
20511-9514R	LEN	9 x 3/4 x .050	14**	2	A	

20572-656R



20556-676RC



20560-606R



20575-634R



20562-610R



20550-414R



20552-418R



20521-318RC



20554-424R



20449-456RP



20512-6066R



20597-960R



20592-650R



20511-9514R



**Tuff Tooth™ design †Available in 25-packs; use "B" as prefix to Item #

*Y = stock item; A = readily available by order

Reciprocating Blades

Standard Wood Cutting Sawzall® Blade

Optimized for best cutting performance in nail-embedded dimensional lumber, OSB, plywood and other engineered lumbers.

Features:

- NAIL GUARD™ – aggressive 5 TPI pattern for faster cuts and a unique design that protects against tooth fracture
- FANG TIP™ – bites into wood on first contact
- Matrix II bi-metal teeth for greater durability

The AX™ Wood Cutting Sawzall® Blade

In addition to the standard wood cutting blade features, the AX blade also features:

- Thicker, more rigid blade body resists fracturing and bending for maximum durability
- One inch tall blade body reduces blade twisting for straighter, more accurate cuts

Standard Wood Cutting Sawzall Blade



Item #	Code	Length x Width x Thickness (inches)	Teeth Per Inch	Qty. / Pack	Stock*
48-00-5036	MIL	9 x ¾ x .050	5	5	Y

The AX Wood Cutting Sawzall Blade



Item #	Code	Length x Width x Thickness (inches)	Teeth Per Inch	Qty. / Pack	Stock*
48-00-5021	MIL	6 x 1.0 x .062	5	5	Y
48-00-5026	MIL	9 x 1.0 x .062	5	5	Y
48-00-5027	MIL	12 x 1.0 x .062	5	5	Y

Fleam Ground Sawzall® Blade

Deliver fast, clean cuts in clean wood, plywood, OSB and engineered lumber materials

Features:

- Deep gullet design cuts up to 25% faster than standard wood blades
- Fleam ground process creates sharp teeth for clean cuts
- Matrix II bi-metal teeth for greater durability



Item #	Code	Length x Width x Thickness (inches)	Teeth Per Inch	Qty. / Pack	Stock*
48-00-5015	MIL	6 x ¾ x .050	6	5	Y
48-00-5016	MIL	9 x ¾ x .050	6	5	Y

Teeth Recommendations

TPI	Stock Thickness	TPI	Stock Thickness
4/6	½" & above	10	¼" - ⅜"
5/8	⅜" & above	10/14	¼" - ⅜"
6	⅜" & above	14	⅜" - ¼"
7	⅜" & above	18	⅛" - ⅜"
8/12	¼" - ⅜"	24	below ⅛"



Standard Metal Cutting Sawzall® Blade

Optimized for best cutting performance in pipe, conduit, strut, threaded rod, angle iron, duct and other metal materials.

Features:

- Unique combination of relief angles forms a radius on the back of the tooth that reduces stress build-up during cutting and extends blade life
- Precise manufacturing process creates a sharper cutting edge on each tooth for a faster cutting blade
- Matrix II bi-metal teeth for greater durability

The Torch™ Metal Cutting Sawzall® Blade

In addition to the standard metal cutting blade features, the Torch blade also features:

- Thicker, more rigid blade body resists fracturing and bending for maximum durability
- One inch tall blade body reduces blade twisting for straighter, more accurate cuts

Standard Metal Cutting Sawzall Blade



Item #	Code	Length x Width x Thickness (inches)	Teeth Per Inch	Qty. / Pack	Stock*
48-00-5181	MIL	4 x ¾ x .035	14	5	A
48-00-5182	MIL	6 x ¾ x .035	14	5	Y
48-00-5282	MIL	6 x ⅝ x .035	14	5	A
48-00-5187	MIL	9 x ¾ x .035	14	5	A
48-00-5183	MIL	4 x ¾ x .035	18	5	A
48-00-5184	MIL	6 x ¾ x .035	18	5	Y
48-00-5284	MIL	6 x ⅝ x .035	18	5	Y
48-00-5188	MIL	9 x ¾ x .035	18	5	Y
48-00-5189	MIL	12 x ¾ x .035	18	5	Y
48-00-5185	MIL	4 x ¾ x .035	24	5	A
48-00-5186	MIL	6 x ¾ x .035	24	5	Y
48-00-5286	MIL	6 x ⅝ x .035	24	5	Y
48-00-5193	MIL	8 x ⅝ x .035	10/14	5	Y

The Torch Metal Cutting Sawzall Blade



Item #	Code	Length x Width x Thickness (inches)	Teeth Per Inch	Qty. / Pack	Stock*
48-00-5712	MIL	6 x 1.0 x .042	10	5	Y
48-00-5713	MIL	9 x 1.0 x .042	10	5	Y
48-00-5782	MIL	6 x 1.0 x .042	14	5	Y
48-00-5784	MIL	6 x 1.0 x .042	18	5	Y
48-00-5787	MIL	9 x 1.0 x .042	14	5	Y
48-00-5788	MIL	9 x 1.0 x .042	18	5	Y
48-00-5789	MIL	12 x 1.0 x .042	18	5	Y

Reciprocating Blades



BOSCH

Application: Wood

	Application	Item #	Code	Blade Material	Length/Thickness	TPI	Pkg. Qty.	Stock*
	Heavy for wood with nails	RHN126	BOS	Bi-metal	12"/.053"	6	5	Y
		RHN66	BOS	Bi-metal	6"/.053"	6	5	Y
		RHN96	BOS	Bi-metal	9"/.053"	6	5	Y

Application: Metal

	Application	Item #	Code	Blade Material	Length/Thickness	TPI	Pkg. Qty.	Stock*
	Demolition for metal: 1/8"-1/4"	RDM6X2	BOS	Bi-metal	6"/.062"	8+10 2x2	5	Y
	Demolition for metal: 1/8"-1/4"	RDM9X2	BOS	Bi-metal	9"/.062"	8+10 2x2	5	Y
	Ideal for repetitive, precise, accurate angle cuts in thin to medium gauge metal pipes & profiles.	RECM6X2	BOS	Bi-metal	6"/.035"	14+18	5	Y
	Ideal for repetitive, precise, accurate angle cuts in thin to medium gauge metal pipes & profiles.	RECM9X2	BOS	Bi-metal	6"/.035"	14+18	5	Y
	Ideal for demolition work in metal.	REDM6X2	BOS	Bi-metal	6"/.062"	8+10	5	Y
	Ideal for demolition work in metal.	REDM9X2	BOS	Bi-metal	6"/.062"	8+10	5	Y
	Ideal for repetitive, precise, accurate angle cuts in thin to medium gauge metal pipes & profiles.	RESM6X2	BOS	Bi-metal	6"/.042"	8+10	5	Y
	Ideal for repetitive, precise, accurate angle cuts in thin to medium gauge metal pipes & profiles.	RESM9X2	BOS	Bi-metal	9"/.042"	8+10	5	Y
	Sheet metal: 10-16 gauge	RM618	BOS	Bi-metal	6"/.035"	18	5	Y
	Sheet metal: 10-16 gauge	RM918	BOS	Bi-metal	9"/.035"	18	5	Y
	Straight for heavy metal: 1/8"-1/2"	RSM7X2	BOS	Bi-metal	7"/.052"	8+10 2x2	5	Y

Application: Specialty

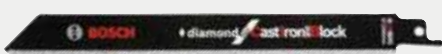
	Application	Item #	Code	Blade Material	Overall Length	Teeth Per Inch	Pkg. Qty.	Stock*
	Plaster/drywall, tile, fiberglass, brick & cast iron	RCB8DG	BOS	Diamond	8"/.050"	Grit	1	Y

*Y = stock item; A = readily available by order

Jigsaw Blades – T-Shank



BOSCH

Application: Wood

	Application	Item #	Code	Blade Material**	Overall Length	Teeth Per Inch	Pkg. Qty.	Stock*
 Progressor for Wood: straight, accurate, splinter-free	Thick/thin, hard/soft woods, including OSB, particle board, plywood, laminated plywood	T234X3	BOS	HCS	4½"	8-12 P**	3	Y
		T234X	BOS	HCS	4½"	8-12 P**	5	A
 Clean for Wood: curved cuts with splinter-free on both sides of surface	Double-sided laminates, laminated particle board, MDF, hard/soft woods, plywood – 5/64"-3/4"	T101A03	BOS	HCS	3¼"	20	3	A
		T101AO	BOS	HCS	3¼"	20	5	Y
		T101A0100	BOS	HCS	3¼"	20	100	A
 Special for Laminate: scroll blade for curved, splinter-free cuts. Ideal for jigsaws without orbital action.	Laminate flooring	T101AOF	BOS	BIM	3¼"	20	5	Y
 Clean for Wood: straight, fine	Hard/soft woods, plastic, plywood, OSB, laminated particle board – 3/16"-1¼"	T101B3	BOS	HCS	4"	10 V**	3	A
		T101B	BOS	HCS	4"	10 V**	5	Y
		T101B100	BOS	HCS	4"	10 V**	100	A
 Clean for Wood: reverse tooth, splinter-free on top of surface	Hard/soft woods, plywood, OSB, laminated particle board, plastics – 3/16"-1¼"	T101BR	BOS	HCS	4"	10	5	Y
		T101BR100	BOS	HCS	4"	10	100	A
 Clean for Hardwood: long life, straight, fine cuts	Hard/soft woods, plywood, laminated particle board, plastics – 3/16"-1¼"	T101BF	BOS	BIM	4"	10 V**	5	Y
 Clean for Wood: straight, clean	Hard/soft woods, plywood, OSB, plastics – ¼"-2¾"	T101D	BOS	HCS	4"	5-6	5	Y
		T101D100	BOS	HCS	4"	5-6	100	A
 Precision for Wood: precise right angle cuts	Hard/soft woods, plywood, particle board, plastics – ¼"-2¾"	T101DP	BOS	HCS	4"	6	5	A
 Basic for Wood: fast, coarse cuts. Ideal for jigsaws without orbital action	Soft wood, plywood, OSB – 7/32"-2¾"	T111C3	BOS	HCS	4"	8	3	A
		T111C	BOS	HCS	4"	8	5	Y
 Basic for Wood: scroll blade for curved cuts	Soft wood, plywood, OSB – 5/16"-¼"	T119B03	BOS	HCS	3¼"	12	3	A
		T119B0	BOS	HCS	3¼"	12	5	Y
 Speed for Wood: straight and very fast	Hard/soft woods, OSB, plywood – ¼"-2¾"	T144D3	BOS	HCS	4"	6	3	A
		T144D	BOS	HCS	4"	6	5	Y
		T144D100	BOS	HCS	4"	6	100	A
 Speed for Hard Wood: straight, very fast for long life	Hard/soft woods, OSB, plywood, wood with nails – ¼"-4"	T144DF	BOS	BIM	4"	5-6	5	Y
 Speed for Wood: scroll blade for curved and fast cuts	Hard/soft woods, OSB, plywood – ¼"-2¾"	T244D3	BOS	HCS	4"	5-6	3	A
		T244D	BOS	HCS	4"	5-6	5	Y
		T244D100	BOS	HCS	4"	5-6	100	A
 Clean for Wood: straight, medium fine	Hard/soft woods, plywood, laminated particle board – 3/16"-2¾"; plastics – 3/16"-1¼"	T301CD	BOS	HCS	4⅝"	8	5	Y
 Clean for Wood: straight, clean	Hard/soft woods, OSB, plywood, plastics – ¼"-3¾"	T301DL	BOS	HCS	5"	6	5	A

**Legend: HCS – High Carbon Steel • HSS – High-Speed Steel • TC – Tungsten Carbide • BIM – Bi-Metal • P – Progressive • V – Variable Gullet



*Y = stock item; A = readily available by order

Jigsaw Blades – T-Shank



BOSCH

Application: Wood

	Application	Item #	Code	Blade Material**	Overall Length	Teeth Per Inch	Pkg. Qty.	Stock*
 Xtra-Clean for Wood: straight, tear-free on top and bottom surface	Wood, laminated particle board, MDF	T308B	BOS	HCS	4½"	12	5	Y
 Speed for Wood: straight and very fast	Hard/soft woods up to 4"	T344D	BOS	HCS	6"	6	5	Y
 Speed for Hard Wood	Hard/soft woods, plywood, OSB, wood with nails – ¼"-4"	T344DF	BOS	BIM	6"	6	5	A

Application: Special

	Application	Item #	Code	Blade Material**	Overall Length	Teeth Per Inch	Pkg. Qty.	Stock*
 Diamond for Hard Tile: clean cutting	Grade 5 porcelain, granite, marble, slate, glass and cement board – ¾"-1½"	T130DG†	BOS	Diamond (grit)	¾"	30 Grit	1	Y
 Special for Stainless Steel: straight cuts, long life	Stainless steel – ¾"-5/64"; steel and nonferrous metal – 1/16"-1/8"	T118AHM	BOS	Carbide (strip)	¾"	24	3	Y
 Special for Stainless Steel: straight cuts, long life	Stainless steel – 5/64"-3/16"; steel and nonferrous metal – 5/64"-7/32"	T118EHM	BOS	Carbide (strip)	¾"	14	3	Y
 Special for Ceramics: file effect for fine, straight or curved cuts	Ceramics, glass, fiberglass – ¾"-5/8"	T130RF3	BOS	Carbide (grit)	¾"	30 Grit	3	Y
 Special for Ceramics: file effect for fine, straight or curved cuts	Ceramics, glass, fiberglass – ¾"-3/8"	T150RF3	BOS	Carbide (grit)	¾"	50 Grit	3	Y
 Special for Fiber and Plaster: fast, coarse cuts	Cement board – ¼"-2¾"; fiberglass and plasterboard – ¼"-¾"	T141HM1	BOS	Carbide (tip)	4"	6	1	A
 Special for Solid Surface: fast, clean cuts	Solid surface materials – 3/16"-2½"	T301CHM3	BOS	Carbide (strip)	45/8"	8	3	A
 Special for Fiber and Plaster: fast, coarse cuts	Cement board – ¼"-3½"; fiberglass and plasterboard – ¼"-2¾"	T341HM1	BOS	Carbide (tip)	5¼"	6	1	A
 Special for Soft Metals: fast, coarse cuts	Cardboard, leathers, carpet, polystyrene and other soft materials	T113A3	BOS	HCS	4"	Knife Edge	3	Y
 Special for Soft Metals: fast, coarse cuts	Cardboard, leathers, carpet, polystyrene and other soft materials	T313AW3	BOS	HCS	6"	Knife Edge	3	A
 Special for Plexiglas: fine and straight cuts	Plexiglas – 5/64"-¾"	T101A3	BOS	HSS	4"	14	3	A
		T101A	BOS	HSS	4"	14	5	Y









†Cool with water; use only with GFCI-protected outlets or adapters or with cordless jigsaw

**Legend: HCS – High Carbon Steel • HSS – High-Speed Steel • TC – Tungsten Carbide • BIM – Bi-Metal • P – Progressive • V – Variable Gullet

Jigsaw Blades – T-Shank

Application: Metal†

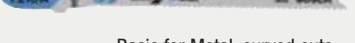
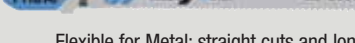
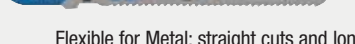
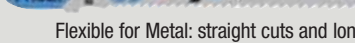
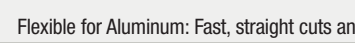

	Application	Item #	Code	Blade Material**	Overall Length	Teeth Per Inch	Pkg. Qty.	Stock*
 Progressor for Metal: fast cuts and long life	Thin metal, pipes and metal profiles, sheet metal up to 8 gauge, metal – $\frac{5}{64}$ "- $\frac{3}{8}$ "; stainless steel – $\frac{1}{16}$ "- $\frac{1}{8}$ "; nonferrous metal – $\frac{5}{64}$ "- $\frac{3}{4}$ "; plastic – $\frac{1}{16}$ "- $\frac{1}{4}$ "; fiberglass – $\frac{3}{64}$ "- $\frac{3}{4}$ "	T123X3	BOS	HSS	4"	10-24 P**	3	A
		T123X	BOS	HSS	4"	10-24 P**	5	Y
		T123X25	BOS	HSS	4"	10-24 P**	25	A
		T123X100	BOS	HSS	4"	10-24 P**	100	A
 Basic for Metal: straight cuts	Sheet metal 17-26 gauge, very thin metal – $\frac{1}{64}$ "- $\frac{3}{64}$ " (ferrous and nonferrous)	T118G	BOS	HSS	$3\frac{5}{8}$ "	36	5	Y
 Basic for Metal: straight cuts	Sheet metal 10-16 gauge, thin metal – $\frac{1}{16}$ "- $\frac{1}{8}$ " (ferrous and nonferrous)	T118A3	BOS	HSS	$3\frac{5}{8}$ "	17-24 P**	3	A
		T118A	BOS	HSS	$3\frac{5}{8}$ "	17-24 P**	5	Y
		T118A100	BOS	HSS	$3\frac{5}{8}$ "	17-24 P**	100	A
 Basic for Metal: straight cuts	Medium thin metal – $\frac{1}{8}$ "- $\frac{1}{4}$ " (ferrous and nonferrous)	T118B3	BOS	HSS	$3\frac{5}{8}$ "	11-14 P**	3	A
		T118B	BOS	HSS	$3\frac{5}{8}$ "	11-14 P**	5	Y
		T118B100	BOS	HSS	$3\frac{5}{8}$ "	11-14 P**	100	A
 Basic for Metal: straight cuts	Profiles, sheet metal 10-16 gauge, thin metal – $\frac{1}{16}$ "- $\frac{1}{8}$ " (ferrous and nonferrous), pipes less than $2\frac{1}{2}$ " diameter, tube stock, angle iron	T318A	BOS	HSS	$5\frac{1}{4}$ "	24	5	Y
		T318A100	BOS	HSS	$5\frac{1}{4}$ "	24	100	A
 Basic for Metal: straight cuts	Pipes, sheet metal, medium-thin metal – $\frac{5}{64}$ "- $\frac{5}{16}$ " (ferrous and nonferrous), profiles $\frac{5}{64}$ "- $\frac{3}{8}$ " diameter	T318B	BOS	HSS	$5\frac{1}{4}$ "	14	5	A
		T318B100	BOS	HSS	$5\frac{1}{4}$ "	14	100	A
 Basic for Metal: curved cuts	Sheet metal 10-16 gauge, thin metal – $\frac{1}{16}$ "- $\frac{1}{8}$ " (ferrous and nonferrous)	T218A	BOS	HSS	$3\frac{5}{8}$ "	17-24 P**	5	Y
 Flexible for Metal: straight cuts and long life	Sheet metal 10-16 gauge, thin metal – $\frac{1}{16}$ "- $\frac{1}{8}$ " (ferrous and nonferrous)	T118AF	BOS	BIM	$3\frac{5}{8}$ "	17-24 P**	5	Y
		T118AF100	BOS	BIM	$3\frac{5}{8}$ "	17-24 P**	100	A
 Flexible for Metal: straight cuts and long life	Medium thin metal – $\frac{5}{64}$ "- $\frac{7}{32}$ " (ferrous and nonferrous)	T118EF	BOS	BIM	$3\frac{5}{8}$ "	11-18 P**	5	Y
		T118EF100	BOS	BIM	$3\frac{5}{8}$ "	11-18 P**	100	A
 Flexible for Metal: straight cuts and long life	Medium thin metal – $\frac{1}{8}$ "- $\frac{1}{4}$ " (ferrous and nonferrous)	T118BF	BOS	BIM	$3\frac{5}{8}$ "	11-14 P**	5	Y
 Flexible for Aluminum: Fast, straight cuts and long life	Aluminum – $\frac{3}{16}$ "- $\frac{5}{8}$ "; plastic – $\frac{3}{16}$ "- $\frac{1}{4}$ "; fiberglass – $\frac{3}{16}$ "- $\frac{3}{4}$ "	T127DF	BOS	BIM	4"	8	5	A
		T127DF100	BOS	BIM	4"	8	100	A
 Special for Aluminum: fast, straight cuts	Aluminum – $\frac{3}{16}$ "- $\frac{5}{8}$ "; plastic – $\frac{3}{16}$ "- $\frac{1}{4}$ "; fiberglass – $\frac{3}{16}$ "- $\frac{3}{4}$ "	T127D	BOS	HSS	4"	8	5	Y
		T127D100	BOS	HSS	4"	8	100	A
 Special for Aluminum: fast, curved cuts	Aluminum – $\frac{3}{16}$ "- $\frac{5}{8}$ "; plastic – $\frac{3}{16}$ "- $\frac{1}{4}$ "; fiberglass – $\frac{3}{16}$ "- $\frac{3}{4}$ "	T227D	BOS	HSS	4"	8	5	Y

†If metal cutting, use cutting oil, turpentine or a mixture of turpentine and petroleum oil to cool blade.



**Legend: HCS – High Carbon Steel • HSS – High-Speed Steel • TC – Tungsten Carbide • BIM – Bi-Metal • P – Progressive • V – Variable Gullet

*Y = stock item; A = readily available by order

Jigsaw Blades - T-Shank

Application: All Purpose



	Application	Item #	Code	Blade Material**	Overall Length	Teeth Per Inch	Pkg. Qty.	Stock*
 Accurate for Wood with Nails: straight cuts	Wood with nails, OSB, plastic – 3/16"-1 1/4"	T111CF	BOS	BIM	4"	8	5	A
 Progressor for Wood with Nails: progressive tooth design for fast cuts and longer life	Thick/thin materials like wood with nails, plywood, particle board – 3/16"-3 5/8"; metal – 3/16"-3/8"; nonferrous metal and aluminum – 5/64"-1 1/4"	T345XF3	BOS	BIM	5 1/4"	5-10 P**	3	A
		T345XF	BOS	BIM	5 1/4"	5-10 P**	5	A
		T345XF25	BOS	BIM	5 1/4"	5-10 P**	25	A
		T345XF100	BOS	BIM	5 1/4"	5-10 P**	100	A
 Accurate for Wood with Nails: scroll blade for curve cuts	Wood with nails, plastic – 1/8"-1 1/4"; nonferrous metal and aluminum – 1/8"-1/2"	T211HF	BOS	BIM	3"	10	5	A

**Legend: HCS – High Carbon Steel • HSS – High-Speed Steel • TC – Tungsten Carbide • BIM – Bi-Metal • P – Progressive • V – Variable Gullet

T-shank Jigsaw Blade Assortment Set

5-piece set contains:

- Includes one each: T101B, T144D, T119BO, T118A, T118B

Item #	Code	Description	Stock*
T500	BOS	5-Piece Jigsaw Blade Set	Y



T-shank Contractor Jigsaw Blade Assortment Set

21-piece set contains:

- Includes (5) T101B, (5) T144DP, (2) T345XF, (5) T118A, (2) T123X, (2) T141HM1, case

Item #	Code	Description	Stock*
TC21HC	BOS	21-Piece Jigsaw Blade Set	Y



Jigsaw Blades - U-Shank

Bi-Metal Jigsaw Blades for Wood & Metal

Item #	Code	Length x Width x Thickness (inches)	Teeth Per Inch	Qty. Per Pack	Application	Stock*
480J	LEN	4 1/2 x 3/8 x .050	10	2	Wood, nail-embedded wood: 1/4" - 2" thick. All steels: 1/8" - 1/2" thick. Soft metals: 1/8" - 1" thick.	Y
314J	LEN	3 x 3/8 x .037	14	2	Steels: 3/32" - 1/4". Nonferrous metal: 3/32" - 3/8".	Y
318J	LEN	3 x 3/8 x .037	18	2	Stainless steel, structural steel: 1/16" - 3/16".	Y



CAN'T FIND THE PRODUCT YOU NEED? CALL US!

*Y = stock item; A = readily available by order

Hacksaw Blades



Bi-Metal Hand Hacksaw Blade

Bi-metal construction allows blades to bend and flex without breaking.

Item #	Code	Length x Width (Inches)	Teeth Per Inch	Stock*
20140-V018HE	LEN	10 x 1/2	18	A
20140-V024HE	LEN	10 x 1/2	24	A
20140-V032HE	LEN	10 x 1/2	32	A
20140-V214HE	LEN	12 x 1/2	14	A
218HE	LEN	12 x 1/2	18	Y
224HE	LEN	12 x 1/2	24	Y
232HE	LEN	12 x 1/2	32	Y

Power Handsaw Blades



Regular Cut Blade



Flush Cut Blade

FineCut™ Power Handsaw Blade

- High-alloy steel blades with hardened ground teeth
- Ultra-fine tooth design provides smooth, tear-free cuts
- Flex-resistant, steel blade guides provide accurate guidance

Item #	Code	Length (Inches)	TPI	Type of Cut	Application	Stock*
FS180ATU	BOS	5 3/4	20 - fine tooth	Regular	Wood/PVC/plastic	Y
FS180DTU	BOS	5 3/4	8 - tooth	Regular	Wood/PVC/plastic	Y
FS200ABU	BOS	7 7/8	20 - fine tooth	Flush	Wood/PVC	Y

FineCut™ Power Handsaw

see page 24



Cutting Oils



Lenox ProTool LUBE®

Professional Lubricant for Cutting Tools

Item #	Code	Description	Stock*
68040	LEN	ProTool LUBE - 6 oz.	Y



Hawg Wash®

Water soluble, chemical fluid concentrate containing stable sulphur and chlorine additives. Hawg Wash cutting fluid is specifically designed for extreme pressure application. Combines with water; one 16 oz. bottle makes one gallon of solution.

Item #	Code	Description	Stock*
49-32-0081	MIL	Hawg Wash - 16 oz.	Y



Premium All-Purpose Thread Cutting Oil

- Two cutting oils in one
- For hand tools and high-speed thread cutting machines
- Use with steel, brass, copper, black iron, wrought iron and galvanized iron

Item #	Code	Size	Stock*
73412	MK	1 pint	A
72414	MK	1 gallon	Y
73413	MK	1 quart	Y



*Y = stock item; A = readily available by order

Hole Saws



Bi-Metal Hole Saw

Long Lasting, Fast Cutting and Versatile

- TUFF TOOTH™ design is reinforced to cut stronger and last longer
- Patented VARI-TOOTH® design resists tooth strippage
- High speed steel teeth resist breaking and offer extended life
- Thick backing plate with holes for drive pins resists damage due to high torque
- One hole saw per box



Item #	Code	Diameter (Inches)	Pipe Tap (Inches)	Pipe Entrance (Inches)	Use Arbor Number	Stock*
HS916	LEN	9/16			1L, 4L, 5L	A
HS58	LEN	5/8			1L, 4L, 5L	Y
HS1116	LEN	11/16			1L, 4L, 5L	A
HS34	LEN	3/4	1/2	3/8	1L, 4L, 5L	Y
HS1316	LEN	13/16			1L, 4L, 5L	A
HS78	LEN	7/8	3/4	1/2	1L, 4L, 5L	Y
HS1516-LEN	LEN	15/16			1L, 4L, 5L	A
HS1	LEN	1			1L, 4L, 5L	Y
HS1-116	LEN	1 1/16			1L, 4L, 5L	A
HS118	LEN	1 1/8	1	3/4	1L, 4L, 5L	Y
HS1-316	LEN	1 3/16			1L, 4L, 5L	A
HS114	LEN	1 1/4			2L, 3L, 6L	Y
HS1-516	LEN	1 5/16			2L, 3L, 6L	A
HS138	LEN	1 3/8		1	2L, 3L, 6L	Y
HS1716	LEN	1 7/16			2L, 3L, 6L	A
HS112	LEN	1 1/2	1 1/4		2L, 3L, 6L, 7L	Y
HS1916	LEN	1 9/16			2L, 3L, 6L, 7L	A
HS158	LEN	1 5/8			2L, 3L, 6L, 7L	Y
HS1-1116	LEN	1 11/16			2L, 3L, 6L, 7L	A
HS134	LEN	1 3/4	1 1/2	1 1/4	2L, 3L, 6L, 7L	Y
HS11316	LEN	1 13/16			2L, 3L, 6L, 7L	A
HS178	LEN	1 7/8			2L, 3L, 6L, 7L	Y
HS2	LEN	2		1 1/2	2L, 3L, 6L, 7L	Y
HS2916	LEN	2 9/16			2L, 3L, 6L, 7L	A
HS218	LEN	2 1/8			2L, 3L, 6L, 7L	Y

Item #	Code	Diameter (Inches)	Pipe Tap (Inches)	Pipe Entrance (Inches)	Use Arbor Number	Stock*
HS214	LEN	2 1/4	2		2L, 3L, 6L, 7L	Y
HS2-516	LEN	2 5/16			2L, 3L, 6L, 7L	A
HS238	LEN	2 3/8			2L, 3L, 6L, 7L	Y
HS212	LEN	2 1/2		2	2L, 3L, 6L, 7L	Y
HS2916	LEN	2 9/16			2L, 3L, 6L, 7L	A
HS258	LEN	2 5/8	2 1/2		2L, 3L, 6L, 7L	Y
HS234	LEN	2 3/4			2L, 3L, 6L, 7L	Y
HS278	LEN	2 7/8			2L, 3L, 6L, 7L	A
HS3	LEN	3		2 1/2	2L, 3L, 6L, 7L	Y
HS318	LEN	3 1/8			2L, 3L, 6L, 7L	Y
HS314	LEN	3 1/4	3		2L, 3L, 6L, 7L	Y
HS338	LEN	3 3/8			2L, 3L, 6L, 7L	Y
HS312	LEN	3 1/2			2L, 3L, 6L, 7L	Y
HS358	LEN	3 5/8		3	2L, 3L, 6L, 7L	Y
HS334	LEN	3 3/4	3 1/2		2L, 3L, 6L, 7L	Y
HS378	LEN	3 7/8			2L, 3L, 6L, 7L	A
HS4-LEN	LEN	4			2L, 3L, 6L, 7L	Y
HS418	LEN	4 1/8		3 1/2	2L, 3L, 6L, 7L	Y
HS414	LEN	4 1/4	4		2L, 3L, 6L, 7L	Y
HS438	LEN	4 3/8			2L, 3L, 6L, 7L	A
HS412	LEN	4 1/2	4 1/2		2L, 3L, 6L, 7L	Y
HS458	LEN	4 5/8		4	2L, 3L, 6L, 7L	A
HS434	LEN	4 3/4			2L, 3L, 6L, 7L	Y
HS5	LEN	5			2L, 3L, 6L, 7L	Y
HS512	LEN	5 1/2			2L, 3L, 6L, 7L	Y
HS6	LEN	6			2L, 3L, 6L, 7L	Y

Carbide Tipped Hole Saw

Designed for Cutting Tile and Stainless Steel

- Heat resistant carbide teeth for long life
- Thick backing plate resists damage and increases life
- Unique tooth configuration provides ability to cut in stainless steel like no other
- One hole saw per box



Item #	Code	Diameter (Inches)	Pipe Tap (Inches)	Pipe Entrance (Inches)	Use Arbor Number	Stock*
16CT	LEN	1			1L, 4L	Y
24CT	LEN	1 1/2	1 1/4		2L, 7L	Y
28CT	LEN	1 3/4	1 1/2	1 1/4	2L, 7L	Y

Hole Saws



Master-Grit® Hole Saw

Best for Cutting Abrasive Materials

- Tungsten carbide grit cuts through fiberglass, ceramic tile, laminates and other abrasive materials
- Carbide grit edge will not snag or chip when cutting thin materials
- One hole saw per box

Item #	Code	Diameter (Inches)	Pipe Tap (Inches)	Pipe Entrance (Inches)	Use Arbor Number	Stock*
29912-12CG	LEN	3/4	1/2	1/8	1L, 1SL, 4L	A
29998-20MMCG	LEN	25/32			1L, 1SL, 4L	A
29914-14CG	LEN	7/8	3/4	1/2	1L, 1SL, 4L	A
16CG	LEN	1			1L, 4L	Y
18CG	LEN	1 1/8	1	3/4	1L, 4L	Y
20CG	LEN	1 1/4			2L	Y
22CG	LEN	1 3/8		1	2L	Y
24CG	LEN	1 1/2	1 1/4		2L, 7L	Y
28CG	LEN	1 3/4	1 1/2	1 1/4	2L, 7L	Y
32CG	LEN	2		1 1/2	2L, 2SL, 7L	Y
34CG	LEN	2 1/8			2L, 2SL, 7L	Y
29936-36CG	LEN	2 1/4	2		2L, 2SL, 7L	A
29938-38CG	LEN	2 3/8			2L, 2SL, 7L	A
40CG	LEN	2 1/2		2	2L, 2SL, 7L	Y
29941-41CG	LEN	2 9/16			2L, 2SL, 7L	A
29942-42CG	LEN	2 5/8	2 1/2		2L, 2SL, 7L	A
48CG	LEN	3		2 1/2	2L, 2SL, 7L	Y
29952-52CG	LEN	3 1/4	3		2L, 2SL, 7L	A
29958-58CG	LEN	3 5/8		3	2L, 2SL, 7L	A
64CG	LEN	4			2L, 2SL, 7L	Y
29966-66CG	LEN	4 1/8		3 1/2	2L, 2SL, 7L	A
30297-123CT	LEN	1/4" Carbide Tipped Pilot Drill - fits 1L, 2L, 4L, 7L				A
65CTPD	LEN	1/4" Carbide Tipped Pilot Drill - fits 5L, 6L				Y

LENOX

Pilot Drill



Item #	Code	Description	Chuck Size	Use Arbor Number	Stock*
4321	LEN	Pilot Drill - 1/pack	1/4"	1L, 2L, 4L	Y
56PD	LEN	Pilot Drill - 1/pack	1/4"	3L, 5L, 6L, 7L	Y

Arbor

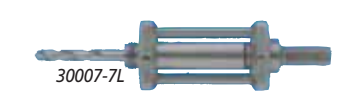
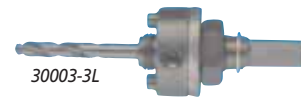
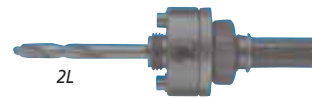
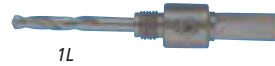

Item #	Code	Fits Hole Saw	Shank Type	Chuck Size (Inches)	Stock*
1L	LEN	9L-19L	Hex	1/2 & larger	Y
2L	LEN	20L-96L	Hex	1/2 & larger	Y
30003-3L	LEN	20L-96L	Solid/Hex	1/2 & larger	A
4L	LEN	9L-19L	3-sided	1/4 & larger	Y
5L	LEN	9L-19L	Hex	3/8 & larger	Y
6L	LEN	20L-96L	Hex	3/8 & larger	Y
30007-7L	LEN	24L-96L	Hex	3/8 & larger	A

Shank Extension

- Two set screws to lock bit in place



Item #	Code	Length	Shank Size	Stock*
30843	LEN	10"	3/8"	Y
30846	LEN	5 1/2"	1/2"	Y
30847	LEN	12"	1/2"	Y
30848	LEN	18"	1/2"	Y

*Y = stock item; A = readily available by order

Hole Saws

Big Daddy™ Industrial Kit

26-piece bi-metal kit
contains:

- Hole saws: 3/4", 7/8", 1", 1 1/8", 1 3/8", 1 1/2", 1 3/4", 2", 2 1/8", 2 1/4", 2 1/2", 2 11/16", 3", 3 1/4", 3 3/8", 3 5/8", 3 3/4", 4 1/8", 4 1/2", 4 3/4"
- Arbors: 1L, 2L, 5L
- (2) #4321 and (1) #56PD pilot drills



Item #	Code	Description	Stock*
2000G	LEN	26-Piece Industrial Hole Saw Kit	Y

LENOX



Plumber's Kit

10-piece bi-metal kit
contains:

- Hole saws: 3/4", 7/8", 1 1/8", 1 1/2", 1 3/4", 2 1/4"
- Arbors: 2L, 5L
- (1) #4321 pilot drill
- (1) Arbor adapter



Item #	Code	Description	Stock*
30808-600P	LEN	10-Piece Plumber's Hole Saw Kit	A

General Purpose Kit

17-piece bi-metal kit contains:

- Hole saws: 5/8", 3/4", 7/8", 1", 1 1/8", 1 1/4", 1 3/8", 1 1/2", 1 3/4", 2", 2 1/2", 3"
- Arbors: 1L, 2L
- (3) #4321 pilot drills

Item #	Code	Description	Stock*
1200G-LEN	LEN	17-Piece General Purpose Hole Saw Kit	Y

Electrician's Kit

10-piece bi-metal kit
contains:

- Hole saws: 7/8", 1 1/8", 1 3/8", 1 3/4", 2", 2 1/2"
- Arbors: 2L, 5L
- (1) #4321 pilot drill
- (1) Arbor adapter



Item #	Code	Description	Stock*
600L	LEN	10-Piece Electrician's Hole Saw Kit	Y

Electrician's Kit

17-piece bi-metal kit
contains:

- Hole saws: 3/4", 7/8", 1 1/8", 1 3/8", 1 3/4", 2", 2 1/2", 2 11/16", 3", 3 5/8", 4 1/8", 4 3/4"
- Arbors: 2L, 5L
- (2) #4321 and (1) #56PD pilot drills



Item #	Code	Description	Stock*
1200L	LEN	17-Piece Electrician's Hole Saw Kit	Y

CAN'T FIND IT?

We have many products not included in this catalog. If you don't find it, call us. We may have or can get just what you're looking for. New items are always being added. Send us your order or inquiries when you want an item that is not listed...and thanks!

*Y = stock item; A = readily available by order

Hole Saws

Master Cobalt® Bi-Metal Hole Saw

This premium line of professional quality hole saws features an M3 high-speed steel cutting edge that is electron beam welded to a tough steel backer. Caps stand up to abuse and punishment, yet are lighter and easier to use than those of competitors. Positive rake tooth design provides better chip clearance as teeth cut into wood, plastic or any machinable metal. The 1 1/2" cutting depth cuts easily through 2 x 4s. A separate arbor is required.

Packaged one hole saw per box



Item #	Code	Diameter	Pipe Tap Size	Pipe Ent. Size	Stock*
For AV09 - AV244 use any of the following arbors: M24, M24K, M34, M44 or M44K					
AV09	MOR	9/16"			Y
AV10	MOR	5/8"			Y
AV11	MOR	11/16"			Y
AV12	MOR	3/4"	1/2"	3/8"	Y
AV13	MOR	13/16"			Y
AV14	MOR	7/8"	3/4"	1/2"	Y
AV15	MOR	15/16"			Y
AV16	MOR	1"			Y
AV17	MOR	1 1/16"			Y
AV18	MOR	1 1/8"	1"	3/4"	Y
AV19	MOR	1 3/16"			Y
AV204	MOR	1 1/4"			A
AV224	MOR	1 3/8"			A
AV244	MOR	1 1/2"			A
For AV20 - AV385 use any of the following arbors: M35PS, M45, M45P, M46PS, M55P or M44K					
AV20	MOR	1 1/4"			Y
AV21	MOR	1 5/16"			Y
AV22	MOR	1 3/8"		1"	Y
AV23	MOR	1 7/16"			A
AV24	MOR	1 1/2"	1 1/4"		Y
AV25	MOR	1 9/16"			Y
AV26	MOR	1 5/8"			Y
AV27	MOR	1 11/16"			A
AV28	MOR	1 3/4"	1 1/2"	1 1/4"	Y
AV29	MOR	1 3/16"			A
AV30	MOR	1 7/8"			Y

Item #	Code	Diameter	Pipe Tap Size	Pipe Ent. Size	Stock*
For AV20 - AV38 use any of the following arbors: M35PS, M45, M45P, M46PS, M55P or M44K					
AV32	MOR	2"		1 1/2"	Y
AV33	MOR	2 1/16"			Y
AV34	MOR	2 1/8"			Y
AV36	MOR	2 1/4"	2"		Y
AV37	MOR	2 5/16"			A
AV38	MOR	2 3/8"			Y
For AV40 - AV96 use any of the following arbors: M45P, M46PS, M55P or M44K					
AV40-MOR	MOR	2 1/2"		2"	Y
AV41	MOR	2 9/16"			Y
AV42	MOR	2 5/8"	2 1/2"		Y
AV44	MOR	2 3/4"			Y
AV46	MOR	2 7/8"			Y
AV48	MOR	3"		2 1/2"	Y
AV50	MOR	3 1/8"			Y
AV52	MOR	3 1/4"	3"		Y
AV54	MOR	3 3/8"			Y
AV56	MOR	3 1/2"			Y
AV58	MOR	3 5/8"		3"	Y
AV60	MOR	3 3/4"	3 1/2"		Y
AV62	MOR	3 7/8"			A
AV64	MOR	4"			Y
AV66	MOR	4 1/8"		3 1/2"	Y
AV68	MOR	4 1/4"	4"		Y
AV70	MOR	4 3/8"			A
AV72	MOR	4 1/2"	4 1/2"	4"	Y
AV76	MOR	4 3/4"			A
AV80	MOR	5"			Y
AV88	MOR	5 1/2"			Y
AV92	MOR	5 3/4"			A
AV96	MOR	6"			Y

Pilot Drill

Item #	Code	Description	Stock*
MPD401	MOR	4 5/16" x 1/4" - shank ground 3 sides, split point	Y
MPD4S01	MOR	2 7/8" x 1/4" - for M24, M34 & M35PS arbors	Y
TACPD4S	MOR	3 1/16" x 1/4" - carded	Y



Master Cobalt® Bi-Metal Hole Saw Maintenance Kit

A handy, general purpose kit for plumbing and electrical jobs on pipe and conduit through 2".

13-piece kit contains:

- Hole saws (1 each) - 3/4", 7/8", 1 1/8", 1 3/8", 1 1/2", 1 3/4", 2", 2 1/4", 2 1/2", 3"
- Arbors (1 each) - M24K, M44, M45P
- Extension (1) - 12"

Item #	Code	Description	Stock*
AV100	MOR	Variable Pitch Hole Saw Maintenance Kit	Y

Hole Saw Arbor

Heavy-duty, carbon steel arbor with pilot drill adapts Morse hole saws to any drill used by professionals.

Item #	Code	Shank Size	Thread Size	Pilot Drill #	Chuck Size	Fits Saws	Follow Through	Stock*
M34	MOR	3/8 Hex	1/2-20	MPD4S01	3/8	9/16" - 1 3/16"	3/4" - 1 1/2"	Y
M35PS	MOR	3/8 Hex	5/8-18	MPD4S01	3/8	1 1/4" - 6"	1 1/2" - 6"	Y
M45P	MOR	7/16 Hex	5/8-18	MPD401	1/2	1 1/4" - 6"	1 1/2" - 6"	Y



Hole Saws

Bi-Metal Hole Saw

- Progressor™ tooth design cuts faster and last longer
- 8% cobalt alloy for longer life and higher heat resistance
- Reinforced shoulder for added strength and longer life
- 10° cutting angle



Item #	Code	Diameter (Inches)	Cut Depth (Inches)	Stock*
HB063	BOS	5/8	1.6	Y
HB075	BOS	3/4	1.6	Y
HB087	BOS	7/8	1.6	Y
HB100	BOS	1	1.6	Y
HB125	BOS	1 1/4	1.54	Y
HB136	BOS	1 3/8	1.54	Y
HB150	BOS	1 1/2	1.6	Y
HB175	BOS	1 3/4	1.6	Y
HB200	BOS	2	1.6	Y
HB212	BOS	2 1/8	1.6	Y
HB225	BOS	2 1/4	1.6	Y
HB250	BOS	2 1/2	1.6	Y
HB300	BOS	3	1.6	Y
HB363	BOS	3 5/8	1.6	Y
HB412	BOS	4 1/8	1.6	Y

Universal Quick Change™ Hole Saw Kit

8-piece bi-metal kit contains:

- Hole saws: 1", 1 1/2", 2 1/8", 2 1/2"
- (1) small adapter (AN01), (1) large adapter (AN02)
- (1) Quick Change™ mandrel (PCM38)
- (1) Pilot bits (HB85PB)



Item #	Code	Description	Stock*
HBUSKIT	BOS	Quick Change Hole Saw Kit	Y

Pilot Bits



HB85PB



HTCTCP

- Use with mandrels: PCM38, PCM12, PCMSDSPL

Item #	Code	Description	Stock*
HB85PB	BOS	3/8" High-Speed Steel Bit	Y
HTCTCP	BOS	4 3/4" Carbide Bit	Y



Plumber's Kit

17-piece bi-metal kit contains:

- Hole saws: 3/4", 7/8", 1 1/8", 1 3/8", 1 3/4", 2 1/4", 2 9/16"
- (3) small adapters (AN01), (4) large adapters (AN02)
- (1) Quick Change™ mandrel (PCM38)
- (2) Pilot bits (HB85PB)
- Plastic case



Item #	Code	Description	Stock*
HB17PL	BOS	17-Piece Plumber's Bi-Metal Hole Saw Kit	Y

Electrician's Kit

19-piece bi-metal kit contains:

- Hole saws: 3/4", 7/8", 1 1/8", 1 3/8", 1 3/4", 2", 2 9/16", 3"
- (3) small adapters (AN01), (5) large adapters (AN02)
- (1) Quick Change™ mandrel (PCM38)
- (2) Pilot bits (HB85PB)
- Plastic case



Item #	Code	Description	Stock*
HB19EL	BOS	19-Piece Electrician's Bi-Metal Hole Saw Kit	Y

Master Kit

25-piece bi-metal kit contains:

- Hole saws: 3/4", 7/8", 1", 1 1/8", 1 3/8", 1 1/2", 1 3/4", 2", 2 1/8", 2 1/2", 3"
- (4) small adapters (AN01), (7) large adapters (AN02)
- (1) Quick Change™ mandrel (PCM38)
- (2) Pilot bits (HB85PB)
- Plastic case



Item #	Code	Description	Stock*
HB25M	BOS	25-Piece Master Bi-Metal Hole Saw Kit	Y

Quick Change™ Mandrel



Item #	Code	Fits Hole Saw	Shank Size	Pilot Bit	Stock*
PCM38	BOS	9/16"-6"	3/8"	High-Speed Steel	Y

Quick Change™ Mandrel Extension



Item #	Code	Description	Shank Type	Stock*
PCME38	BOS	3/8" x 12" Mandrel Extension	Hex	A

Quick Change™ Mandrel Kit

- Includes (1 each) - 3/8" mandrel, small adapter for hole sizes 9/16"-1 3/8", large adapter for hole sizes 1 1/4"-6"

Item #	Code	Description	Stock*
PCM38AN	BOS	Quick Change Mandrel Kit	A



Hole Saws

Diamond Hole Saw with AutoStart™

- Vacuum-brazed diamond grit cuts faster and lasts longer
- Segmented teeth reduce debris and heat build-up
- Integral Quick Change™ adapter changes hole saw sizes and types in seconds and removes material plugs easily



Item #	Code	Diameter (Inches)	Pilot Bit	Stock*
HDG316	BOS	3/16	—	Y
HDG14	BOS	1/4	—	Y
HDG516	BOS	5/16	—	Y
HDG38	BOS	3/8	—	Y
HDG12	BOS	1/2	—	Y
HDG58	BOS	5/8	—	Y
HDG34	BOS	3/4	HDGQA	Y
HDG138	BOS	1 3/8	HDGQA	Y
HDG214	BOS	2 1/4	HDGQA	Y



Diamond Hole Saw Set

Item #	Code	Description	Stock*
HDG138QA	BOS	3-Piece Diamond Hole Saw Kit: (1) mandrel, (1) AutoStart pilot bit, (1) 1 3/8" hole saw	Y
HDG11	BOS	11-Piece Diamond Hole Saw Kit: (1) mandrel, (1) AutoStart pilot bit, one each holesaw - 1/4", 5/16", 3/8", 5/8", 1", 1 1/8", 2", 2 1/4", 2 1/2"	Y
HDGM	BOS	3-Piece Diamond Hole Saw Kit: 3/16", 1/4", 1/2"	Y

AutoStart™ Pilot Bit

Centering Pin for Diamond Hole Saw

- Carbide tip provides extended life in porcelain and granite
- Unique grind starts holes accurately every time
- Spring-loaded, retractable shaft allows walk-free cutting without a pilot hole
- For diamond hole saws 3/4" to 1 1/8"



Item #	Code	Description	Use with Mandrel	Stock*
HDGPB	BOS	AutoStart Pilot Bit	PCM38, PCM12, PCMSPL	A

Quick Change™ Mandrel with AutoStart™



Item #	Code	Fits Hole Saw	Shank Size	Pilot Bit	Stock*
HDGQA	BOS	3/4"-4 1/8"	3/8"	AutoStart Carbide	Y



Carbide MultiConstruction™ Hole Saw

- Diamond ground carbide teeth cut extremely fast in wood and a wide variety of material
- Drop-shaped chip clearance slots for fast drilling
- Integral Quick Change™ adapter provides fast hole saw changes and easier plug removal

Item #	Code	Diameter (Inches)	Cut Depth (Inches)	Stock*
HTC118	BOS	1 1/16	2 1/4	Y
HTC137	BOS	1 3/8	2 1/4	Y
HTC175	BOS	1 3/4	2 1/4	Y
HTC212	BOS	2 1/8	2 1/4	Y
HTC256	BOS	2 9/16	2 1/4	Y
HTC300	BOS	3	2 1/4	Y
HTC312	BOS	3 1/8	2 1/4	Y
HTC412	BOS	4 1/8	2 1/4	Y



MultiConstruction™ Hole Saw Set

Item #	Code	Description	Stock*
HTC5HPC	BOS	5-Piece Carbide Hole Saw Kit: (1) Quick Change mandrel, (2) pilot bits (HTCTCP), (1) 3 1/4", (1) 4 1/8"	Y
HTC8PC	BOS	8-Piece Carbide Hole Saw Kit: (1) Quick Change mandrel, (2) pilot bits (HTCTCP), one each holesaw - 1", 1 1/8", 1 3/8", 1 3/4", 2 1/4"	Y

Hole Enlarger Kit

Enlarge existing holes quickly, easily and accurately

- Integral Quick Change™ adapter provides fast hole saw changes
- Large and small washers allow two different hole saw sizes to be used together—smaller hole saw acts as a pilot bit and larger hole saw cuts new hole
- Includes (1) PCM38 adapter, (1) adapter for hole saw enlargement and (3) washers



Item #	Code	Description	Stock*
HE1	BOS	Hole Enlarger Kit (hole saws not included)	Y

Drill Bits - Wood Drilling



Bellhanger Bit

For installers of all types of small wire systems—computer, security, phone cable, etc. Extra length for extra reach. Pull the wire back through the hole by simply attaching a line or wire to the bit.

Item #	Code	Diameter	Overall Length	Stock*
48-13-7125	MIL	1/4"	12"	Y
48-13-7131	MIL	5/16"	12"	A
48-13-7137	MIL	3/8"	12"	A
48-13-7218	MIL	3/16"	18"	Y
48-13-7225	MIL	1/4"	18"	Y
48-13-7231	MIL	5/16"	18"	Y
48-13-7237	MIL	3/8"	18"	Y
48-13-7243	MIL	7/16"	18"	Y
48-13-7325	MIL	1/4"	24"	Y
48-13-7337	MIL	3/8"	24"	A



Forstner Bit

• Chrome steel alloy; 3/8" shank

Item #	Code	Diameter	Stock*
FB004	BOS	1/4"	Y
FB006	BOS	3/8"	Y
FB008	BOS	1/2"	Y
FB010	BOS	5/8"	Y
FB012	BOS	3/4"	Y
FB014	BOS	7/8"	A
FB016	BOS	1"	Y
FB018	BOS	1 1/8"	Y
FB020	BOS	1 1/4"	Y
FB022	BOS	1 3/8"	A
FB024	BOS	1 1/2"	Y
FB026	BOS	1 5/8"	Y
FB028	BOS	1 3/4"	Y
FB030	BOS	1 7/8"	A
FB032	BOS	2"	Y
FB034	BOS	2 1/8"	A

*Y = stock item; A = readily available by order

Selffeed Bit

All sizes have removable and replaceable feed screws that provide fast, effortless feeding, even in gummy woods. Two feed screws furnished with each bit. Inside cutting plane shaves hole radius for clean, smooth holes without pressure. Selffeed bits have 7/16" hex quick change shanks.



Item #	Code	Description	Recommended w/Drill Models	Std. Pipe Sizes	Stock*
48-25-1001	MIL	1" Diameter	For 1/2" pistol grip & larger drills.	1/2"	Y
48-25-1121	MIL	1 1/8" Diameter		3/4"	Y
48-25-1251	MIL	1 1/4" Diameter			Y
48-25-1371	MIL	1 3/8" Diameter	For 1/2" D-handle drills & larger drills.	1"	Y
48-25-1501	MIL	1 1/2" Diameter		1"	Y
48-25-1751	MIL	1 3/4" Diameter		1 1/2"	Y
48-25-2001	MIL	2" Diameter			Y
48-25-2121	MIL	2 1/8" Diameter			Y
48-25-2251	MIL	2 1/4" Diameter			Y
48-25-2561	MIL	2 9/16" Diameter	For 1/2" D-handle drills & larger drills, except 1250-1.	2"	Y
48-28-6870	MIL	1/4" Coarse Thread Feed Screw	For small Selffeed bits.		Y
49-96-0060	MIL	1/8" Socket Wrench			A
06-83-2625	MIL	Set Screw			A

Large Selffeed Bit

Large Selffeed bits have double inside cutter blades that shave hole radius for clean, smooth holes without pressure. Replaceable arbor. Bits have 3-milled flat shanks.



Item #	Code	Description	Recommended w/Drill Models	Std. Pipe Sizes	Stock*
48-25-3001	MIL	3" Diameter	1001-1, 1675-1 & larger drills.	2 1/2" [†]	Y
48-25-3621	MIL	3 5/8" Diameter		3" [†]	Y
48-25-4125	MIL	4 1/8" Diameter		3" ^{***}	
48-25-4621	MIL	4 5/8" Diameter	1675-6, 1680-20, 3102-1, 3107-1	4" [†]	Y
48-07-0201	MIL	Replaceable Arbor	For large Selffeed bits.		A
48-25-6880	MIL	3/8" Regular Thread Feed Screw			A
49-96-0070	MIL	5/32" Socket Wrench			A
06-83-3150	MIL	Set Screw			A

[†]Cast iron or copper pipe size.

^{**}PVC pipe with coupling.

7/16" Hex Shank Extensions with Quick Change Shank

For Selffeed bits, auger bits and hole saws (1" diameter and larger) with 7/16" shank. Fits 3-jaw chucks or quick change chucks.



Item #	Code	Replacement Set Screw Item #	Replacement 1/8" Socket Wrench Item #	Length	Stock*
48-28-4001	MIL	06-83-2711	49-96-0060	5 1/2"	Y
48-28-4006	MIL	06-83-2711	49-96-0060	12"	A
48-28-4011	MIL	06-83-2711	49-96-0060	18"	Y
48-28-4016	MIL	06-83-2711	49-96-0060	24"	Y

Drill Bits - Wood Drilling



18" Ship Auger Bit

Precision machined for smooth, wobble-free boring. Large, wide throat design gives excellent chip clearance from deep holes. Self-feeding screw point with one cutting edge and side lip for fast, rough boring in wood. Hardened cutting edges require less resharping. D-handle drills, 1/2" and larger, can use all 1/2" shank bits.

Item #	Code	Diameter	Stock*
48-13-5560	MIL	9/16"	A
48-13-5620	MIL	5/8"	Y
48-13-5680	MIL	11/16"	A
48-13-5750	MIL	3/4"	Y
48-13-5810	MIL	13/16"	A
48-13-5870	MIL	7/8"	A
48-13-5930	MIL	15/16"	Y
48-13-6000	MIL	1"	Y
48-13-6010	MIL	1 1/16"	A
48-13-6120	MIL	1 1/8"	Y
48-13-6250	MIL	1 1/4"	Y
48-13-6370	MIL	1 3/8"	A
48-13-6500	MIL	1 1/2"	Y



Daredevil™ Ship Auger Bit

Designed for superior performance in hitting nails. A unique double cutter and reamer edge provide improved hole quality. A center spine offers additional strength during aggressive drilling and wider flutes allow for better chip removal.



Item #	Code	Diameter (Inches)	Overall Length (Inches)	Flute Length (Inches)	Shank Size (Inches)	Stock*
NKLT06	BOS	3/8	17 1/2	13 1/2	1/4	Y
NKLT08	BOS	1/2	17 1/2	13 1/2	5/16	Y
NKLT09	BOS	9/16	17 1/2	13 1/2	7/16	Y
NKLT10	BOS	5/8	17 1/2	13 1/2	7/16	Y
NKLT11	BOS	11/16	17 1/2	13 1/2	7/16	Y
NKLT13	BOS	13/16	17 1/2	13 1/2	7/16	Y
NKLT14	BOS	7/8	17 1/2	13 1/2	7/16	Y
NKLT15	BOS	15/16	17 1/2	13 1/2	7/16	Y
NKLT16	BOS	1	17 1/2	13 1/2	7/16	Y
NKLT18	BOS	1 1/8	17 1/2	13 1/2	7/16	Y
NKLT20	BOS	2 1/4	17 1/2	13 1/2	7/16	Y
NKST04	BOS	1/4	7 1/2	4	3/16	Y
NKST05	BOS	5/16	7 1/2	4	1/4	Y
NKST06	BOS	3/8	7 1/2	4	1/4	Y
NKST07	BOS	7/16	7 1/2	4	1/4	Y
NKST08	BOS	1/2	7 1/2	4	5/16	Y
NKST09	BOS	9/16	7 1/2	4	7/16	Y
NKST10	BOS	5/8	7 1/2	4	7/16	Y
NKST11	BOS	11/16	7 1/2	4	7/16	Y
NKST12	BOS	3/4	7 1/2	4	7/16	Y
NKST14	BOS	7/8	7 1/2	4	7/16	Y
NKST18	BOS	1 1/8	7 1/2	4	7/16	Y
NKST20	BOS	1 1/4	7 1/2	4	7/16	Y
NKST22	BOS	1 3/8	7 1/2	4	7/16	Y



Drill Bits - Multi-Purpose



MultiConstruction™ Bit

- Grip shank provides aggressive gripping power
- Steep flute with ribs optimizes dust removal in any material
- Sharp, ground cutting edges for fast drilling in hard materials
- Robust head provides long life in impact application

Item #	Code	Diameter (Inches)	Overall Length (Inches)	Usable Length (Inches)	Stock*
MC01	BOS	1/8	3	2	Y
MC02	BOS	5/32	6	4	Y
MC03	BOS	3/16	6	4	Y
MC06	BOS	1/4	6	4	Y
MC07	BOS	1/4	8	6	Y
MC09	BOS	5/16	6	4	Y
MC10	BOS	5/16	10	8	Y
MC12	BOS	3/8	6	4	Y
MC13	BOS	3/8	10	8	Y
MC16	BOS	1/2	6	6	Y
MC17	BOS	1/2	10	10	Y
MC500	BOS	5-Piece Set: MC02, MC03, MC06, MC10, MC12			Y

*Y = stock item; A = readily available by order

Drill Bits - Wood Drilling

Daredevil™ Spade Bit

- Spur and reamer provide cleaner holes
- Contoured paddle for faster chip removal
- Hex shank with power groove reduces slippage
- Full-cone threaded tip for fast and effortless drilling

6" Standard Spade Bit

Item #	Code	Diameter	Stock*
DSB1001	BOS	1/4"	Y
DSB1002	BOS	5/16"	Y
DSB1003	BOS	3/8"	Y
DSB1004	BOS	7/16"	Y
DSB1005	BOS	1/2"	Y
DSB1006	BOS	9/16"	Y
DSB1007	BOS	5/8"	Y
DSB1008	BOS	11/16"	Y
DSB1009	BOS	3/4"	Y
DSB1010	BOS	3/16"	Y
DSB1011	BOS	7/8"	Y
DSB1012	BOS	15/16"	Y
DSB1013	BOS	1"	Y
DSB1015	BOS	1 1/8"	Y
DSB1017	BOS	1 1/4"	Y
DSB1019	BOS	1 3/8"	Y
DSB1021	BOS	1 1/2"	Y



4" Stubby Spade Bit

Item #	Code	Diameter	Stock*
DSB1001	BOS	1/4"	Y
DSB1002	BOS	5/16"	Y
DSB1003	BOS	3/8"	Y
DSB1004	BOS	7/16"	Y
DSB1005	BOS	1/2"	Y
DSB1006	BOS	9/16"	Y
DSB1007	BOS	5/8"	Y
DSB1008	BOS	11/16"	Y
DSB1009	BOS	3/4"	Y



Daredevil™ Spade Bit Extension



Item #	Code	Diameter	Stock*
DSBE1006	BOS	6" Extension	Y
DSBE1012	BOS	12" Extension	Y



Daredevil™ 13-Piece Spade Bit Set

Includes:

- (1) 1/4", (1) 3/8", (1) 1/2", (1) 9/16", (1) 5/8", (1) 11/16", (1) 3/4", (1) 7/8", (1) 1", (1) 1 1/8", (1) 1 1/4", (1) 1 3/8", (1) 1 1/2"

Item #	Code	Diameter	Stock*
DSB5013P	BOS	13-Piece Spade Set	Y

Drill Bits - Glass & Tile

Glass and Tile Bit

- Three-flat shank provides superior grip
- Reinforced head maximizes bit life
- Precision-ground tip reduces bit walking
- Carbide tip for long life in hard materials



Item #	Code	Diameter (Inches)	Stock*
GT100	BOS	1/8	Y
GT200	BOS	3/16	Y
GT300	BOS	1/4	Y
GT400	BOS	5/16	Y
GT500	BOS	3/8	Y
GT600	BOS	1/2	Y
GT700	BOS	5/8	Y
GT800	BOS	3/4	Y
GT900	BOS	7/8	Y
GT1000	BOS	1	Y
GT2000	BOS	4-Piece Set: 1/8, 3/16, 1/4, 5/16	Y
GT3000	BOS	8-Piece Set: 1/8, 3/16, 1/4, 5/16, 3/8, 1/2, 5/8, 3/4 plus Brute Tough™ Case	Y



Glass and Tile Bit

- Spear point reduces cutting pressure for cleaner holes
- Carbide tip for longer life
- Black oxide finish
- Designed for drilling in glass, tile, mirrors and ceramics



Item #	Code	Size (in.)	Decimal Equivalent	Shank Diameter (in.)	Overall Length (in.)	Stock*
039108	TRI	1/8	.135	1/8	2 1/4	A
TG316	TRI	3/16	.197	3/16	2 9/32	Y
039116	TRI	1/4	.260	3/16	2 9/32	A
TG516	TRI	5/16	.322	1/4	3	Y
039124	TRI	3/8	.385	1/4	3 3/8	A
039132	TRI	1/2	.515	1/4	3 7/8	A



*Y = stock item; A = readily available by order

Drill Bits - Metal Drilling



THUNDERBIT™

Jobber Drill: Thunderbit

In hand-held applications, Thunderbits perform similarly to cobalt without the extra expense.

- 135° split-point for quick penetration and reduced “walking”
- Premium-grade M-7 industrial steel for longer life and heat resistance
- Black/bronze oxide finish
- Unique flute design for superior material removal

Material Application: Iron, Steel, Stainless Steel, Wood

Item #	Code	Size (in.)	Decimal Equivalent	Flute Length (in.)	Overall Length (in.)	Stock*
TB116	TRI	1/16	.0625	7/8	1 7/8	A
TB564	TRI	5/64	.0781	1	2	Y
TB332	TRI	3/32	.0938	1 1/4	2 1/4	Y
TB764	TRI	7/64	.1094	1 1/2	2 5/8	A
TB18	TRI	1/8	.1250	1 5/8	2 3/4	Y
TB964	TRI	9/64	.1406	1 3/4	2 7/8	Y
TB532	TRI	5/32	.1562	2	3 1/8	Y
TB1164	TRI	11/64	.1719	2 1/8	3 1/4	A
TB316	TRI	3/16	.1875	2 5/16	3 1/2	Y
TB1364	TRI	13/64	.2031	2 7/16	3 5/8	Y
TB732	TRI	7/32	.2188	2 1/2	3 3/4	A
TB1564	TRI	15/64	.2344	2 5/8	3 7/8	Y
TB14	TRI	1/4	.2500	2 3/4	4	Y
TB1764	TRI	17/64	.2656	2 7/8	4 1/8	A
TB932	TRI	9/32	.2812	2 15/16	4 1/4	A
TB1964	TRI	19/64	.2969	3 1/16	4 3/8	A
TB516	TRI	5/16	.3125	3 3/16	4 1/2	Y
TB2164	TRI	21/64	.3281	3 5/16	4 5/8	A
TB1132	TRI	11/32	.3438	1 7/16	4 3/4	A
TB2364	TRI	23/64	.3594	3 1/2	4 7/8	A
TB38	TRI	3/8	.3750	3 5/8	5	Y
TB2564	TRI	25/64	.3906	3 3/4	5 1/8	A
TB1332	TRII	13/32	.4062	3 7/8	5 1/4	Y
TB2764	TRI	27/64	.4219	3 15/16	5 3/8	A
TB716	TRI	7/16	.4375	4 1/16	5 1/2	Y
TB2964	TRI	29/64	.4531	4 3/16	5 5/8	A
TB1532	TRI	15/32	.4688	4 5/16	5 3/4	A
TB3164	TRI	31/64	.4844	4 3/8	5 7/8	A
TB12	TRI	1/2	.5000	4 1/2	6	Y

*Y = stock item; A = readily available by order



Jobber Drill

- 135° split-point for quick penetration and reduced “walking”
- High-speed steel with black oxide finish
- Heavy-duty construction provides additional strength

Material Application: Iron, Steel, Stainless Steel

Item #	Code	Size (in.)	Decimal Equivalent	Flute Length (in.)	Overall Length (in.)	Stock*
J116	TRI	1/16	.0625	7/8	1 7/8	Y
J564	TRI	5/64	.0781	1	2	Y
J332	TRI	3/32	.0938	1 1/4	2 1/4	Y
J764	TRI	7/64	.1094	1 1/2	2 5/8	Y
J18	TRI	1/8	.1250	1 5/8	2 3/4	A
J964	TRI	9/64	.1406	1 3/4	2 7/8	Y
J532	TRI	5/32	.1562	2	3 1/8	Y
J1164	TRI	11/64	.1719	2 1/8	3 1/4	Y
J316	TRI	3/16	.1875	2 5/16	3 1/2	Y
J1364	TRI	13/64	.2031	2 7/16	3 5/8	Y
J732	TRI	7/32	.2188	2 1/2	3 3/4	A
J1564	TRI	15/64	.2344	2 5/8	3 7/8	Y
J14	TRI	1/4	.2500	2 3/4	4	Y
J1764	TRI	17/64	.2656	2 7/8	4 1/8	Y
J932	TRI	9/32	.2812	2 15/16	4 1/4	Y
J1964	TRI	19/64	.2969	3 1/16	4 3/8	Y
J516	TRI	5/16	.3125	3 3/16	4 1/2	A
J2164	TRI	21/64	.3281	3 5/16	4 5/8	Y
J1132	TRI	11/32	.3438	1 7/16	4 3/4	Y
J2324	TRI	23/64	.3594	3 1/2	4 7/8	A
J38	TRI	3/8	.3750	3 5/8	5	Y
J2564	TRI	25/64	.3906	3 3/4	5 1/8	Y
J1332	TRI	13/32	.4062	3 7/8	5 1/4	Y
J2764	TRI	27/64	.4219	3 15/16	5 3/8	Y
J716	TRI	7/16	.4375	4 1/16	5 1/2	Y
J2964	TRI	29/64	.4531	4 3/16	5 5/8	A
J1532	TRI	15/32	.4688	4 5/16	5 3/4	A
J3164	TRI	31/64	.4844	4 3/8	5 7/8	Y
J12	TRI	1/2	.5000	4 1/2	6	Y

Drill Bits - Metal Drilling

Jobber Drill: Jobber # Bits

- 135° split-point for quick penetration and reduced "walking"
- M-35 cobalt steel for increased heat resistance and longer life
- Black oxide finish
- Heavy-duty construction provides additional strength
- Designed for difficult-to-drill alloy applications



Material Application: Iron, Steel, Stainless Steel



Item #	Code	Size (in.)	Decimal Equivalent	Flute Length (in.)	Overall Length (in.)	Stock*
012401	TRI	1	.2280	2 ⁵ / ₈	3 ⁷ / ₈	A
012402	TRI	2	.2210	2 ⁵ / ₈	3 ⁷ / ₈	A
012403	TRI	3	.2130	2 ¹ / ₂	3 ³ / ₄	A
012404	TRI	4	.2090	2 ¹ / ₂	3 ³ / ₄	A
012405	TRI	5	.2055	2 ¹ / ₂	3 ³ / ₄	A
012406	TRI	6	.2040	2 ¹ / ₂	3 ³ / ₄	A
012407	TRI	7	.2010	2 ⁷ / ₁₆	3 ⁵ / ₈	Y
012408	TRI	8	.1990	2 ⁷ / ₁₆	3 ⁵ / ₈	Y
012409	TRI	9	.1960	2 ⁷ / ₁₆	3 ⁵ / ₈	A
012410	TRI	10	.1935	2 ⁷ / ₁₆	3 ⁵ / ₈	A
012411	TRI	11	.1910	5 ⁵ / ₁₆	3 ¹ / ₂	A
012412	TRI	12	.1890	5 ⁵ / ₁₆	3 ¹ / ₂	A
012413	TRI	13	.1850	5 ⁵ / ₁₆	3 ¹ / ₂	A
012414	TRI	14	.1820	2 ³ / ₁₆	3 ³ / ₈	A
012415	TRI	15	.1800	2 ³ / ₁₆	3 ³ / ₈	Y
012416	TRI	16	.1770	2 ³ / ₁₆	3 ³ / ₈	Y
012417	TRI	17	.1730	2 ³ / ₁₆	3 ³ / ₈	Y
012418	TRI	18	.1695	2 ¹ / ₈	3 ¹ / ₄	A
012419	TRI	19	.1660	2 ¹ / ₈	3 ¹ / ₄	A
012420	TRI	20	.1610	2 ¹ / ₈	3 ¹ / ₄	A
012421	TRI	21	.1590	2 ¹ / ₈	3 ¹ / ₄	Y
012422	TRI	22	.1570	2	3 ¹ / ₈	A
012423	TRI	23	.1540	2	3 ¹ / ₈	A
012424	TRI	24	.1520	2	3 ¹ / ₈	A
012425	TRI	25	.1495	1 ⁷ / ₈	3	Y
012426	TRI	26	.1470	1 ⁷ / ₈	3	Y
012427	TRI	27	.1440	1 ³ / ₄	3	A
012428	TRI	28	.1405	1 ³ / ₄	2 ⁷ / ₈	A
012429	TRI	29	.1360	1 ³ / ₄	2 ⁷ / ₈	Y
012430	TRI	30	.1285	1 ⁵ / ₈	2 ³ / ₄	Y

Item #	Code	Size (in.)	Decimal Equivalent	Flute Length (in.)	Overall Length (in.)	Stock*
012431	TRI	31	.1200	1 ⁵ / ₈	2 ³ / ₄	A
012432	TRI	32	.1160	1 ⁵ / ₈	2 ³ / ₄	A
012433	TRI	33	.1130	1 ¹ / ₂	2 ⁵ / ₈	A
012434	TRI	34	.1110	1 ¹ / ₂	2 ⁵ / ₈	A
012435	TRI	35	.1100	1 ¹ / ₂	2 ⁵ / ₈	A
012436	TRI	36	.1065	1 ⁷ / ₁₆	2 ¹ / ₂	Y
012437	TRI	37	.1040	1 ⁷ / ₁₆	2 ¹ / ₂	A
012438	TRI	38	.1015	1 ⁷ / ₁₆	2 ¹ / ₂	A
012439	TRI	39	.0995	1 ³ / ₈	2 ³ / ₈	A
012440	TRI	40	.0980	1 ³ / ₈	2 ³ / ₈	A
012441	TRI	41	.0960	1 ³ / ₈	2 ³ / ₈	A
012442	TRI	42	.0935	1 ¹ / ₄	2 ¹ / ₄	A
012443	TRI	43	.0890	1 ¹ / ₄	2 ¹ / ₄	A
012444	TRI	44	.0860	1 ¹ / ₈	2 ¹ / ₈	A
012445	TRI	45	.0820	1 ¹ / ₈	2 ¹ / ₈	A
012446	TRI	46	.0810	1 ¹ / ₈	2 ¹ / ₈	A
012447	TRI	47	.0785	1	2	A
012448	TRI	48	.0760	1	2	A
012449	TRI	49	.0730	1	2	A
012450	TRI	50	.0700	1	2	A
012451	TRI	51	.0670	1	2	A
012452	TRI	52	.0635	7 ⁸ / ₁₆	1 ⁷ / ₈	A
012453	TRI	53	.0595	7 ⁸ / ₁₆	1 ⁷ / ₈	A
012454	TRI	54	.0550	7 ⁸ / ₁₆	1 ⁷ / ₈	A
012455	TRI	55	.0520	7 ⁸ / ₁₆	1 ⁷ / ₈	A
012456	TRI	56	.0465	3 ⁴ / ₁₆	1 ³ / ₄	A
012457	TRI	57	.0430	3 ⁴ / ₁₆	1 ³ / ₄	A
012458	TRI	58	.0420	1 ¹ / ₁₆	1 ⁵ / ₈	A
012459	TRI	59	.0410	1 ¹ / ₁₆	1 ⁵ / ₈	A
012460	TRI	60	.0400	1 ¹ / ₁₆	1 ⁵ / ₈	A

Jobber Drill Set - Metal Index

Item #	Code	Size Range	Description	Stock*
T18B	TRI	1/16-1/2" by 32nds	15-piece set: General Purpose, Black Oxide	Y
T17B	TRI	1/16-1/2" by 64ths	29-piece set: General Purpose, Black Oxide	Y
T17HD	TRI	1/16-1/2" by 64ths	29-piece set: Thunderbit, Black/Bronze Oxide	Y



*Y = stock item; A = readily available by order

Drill Bits - Metal Drilling

Aircraft Extension Drill

- 135° split-point for quick penetration and reduced "walking"
- High-speed steel with black oxide finish
- Heavy-duty construction provides additional strength

Material Application: Iron, Steel, Stainless Steel, Wood

Item #	Code	Size (in.)	Decimal Equivalent	Flute Length (in.)	Overall Length (in.)	Stock*
058504	TRI	1/16	.0625	7/8	12	A
058505	TRI	5/64	.0781	1	12	A
058506	TRI	3/32	.0938	1 1/4	12	A
A764X12	TRI	7/64	.1094	1 1/2	12	Y
A18X12	TRI	1/8	.1250	1 5/8	12	Y
A964X12	TRI	9/64	.1406	1 3/4	12	Y
A532X12	TRI	5/32	.1562	2	12	Y
A1164X12	TRI	11/64	.1719	2 1/8	12	Y
A316X12	TRI	3/16	.1875	2 5/16	12	Y
058513	TRI	13/64	.2031	2 7/16	12	A
A732X12	TRI	7/32	.2188	2 1/2	12	Y
058515	TRI	15/64	.2344	2 5/8	12	A
A14X12	TRI	1/4	.2500	2 3/4	12	Y
058517	TRI	17/64	.2656	2 7/8	12	A
058518	TRI	9/32	.2812	2 15/16	12	A
058519	TRI	19/64	.2969	3 1/16	12	A
A516X12	TRI	5/16	.3125	3 3/16	12	Y
A1132X12	TRI	11/32	.3438	1 7/16	12	Y
A38X12	TRI	3/8	.3750	3 5/8	12	Y
058526	TRI	13/32	.4062	3 7/8	12	A
058528	TRI	7/16	.4375	4 1/16	12	A
058530	TRI	15/32	.4688	4 5/16	12	A
A12X12	TRI	1/2	.5000	4 1/2	12	Y



Item #	Code	Size (in.)	Decimal Equivalent	Flute Length (in.)	Overall Length (in.)	Stock*
057504	TRI	1/16	.0625	7/8	6	A
057505	TRI	5/64	.0781	1	6	A
057506	TRI	3/32	.0938	1 1/4	6	A
057507	TRI	7/64	.1094	1 1/2	6	A
A18X6	TRI	1/8	.1250	1 5/8	6	Y
057509	TRI	9/64	.1406	1 3/4	6	A
057510	TRI	5/32	.1562	2	6	A
A1164X6	TRI	11/64	.1719	2 1/8	6	Y
A316X6	TRI	3/16	.1875	2 5/16	6	A
057513	TRI	13/64	.2031	2 7/16	6	A
057514	TRI	7/32	.2188	2 1/2	6	A
057515	TRI	15/64	.2344	2 5/8	6	A
A14X6	TRI	1/4	.2500	2 3/4	6	Y
057517	TRI	17/64	.2656	2 7/8	6	A
057518	TRI	9/32	.2812	2 15/16	6	A
057519	TRI	19/64	.2969	3 1/16	6	A
057520	TRI	5/16	.3125	3 3/16	6	A
057521	TRI	21/64	.3281	3 5/16	6	A
057522	TRI	11/32	.3438	1 7/16	6	A
057523	TRI	23/64	.3594	3 1/2	6	A
057524	TRI	3/8	.3750	3 5/8	6	A
057528	TRI	7/16	.4375	4 1/16	6	A
057532	TRI	1/2	.5000	4 1/2	6	A



See our complete line of Bosch drills on pages 13-20



See our complete line of DeWALT drills on pages 4-10



See our complete line of Milwaukee drills on pages 23-39

*Y = stock item; A = readily available by order

Drill Bits - Metal Drilling



Screw Machine Drill: Cobalt

- 135° split-point for quick penetration and reduced “walking”
- M-35 cobalt steel for increased heat resistance and longer life
- Black oxide finish
- Heavy-duty construction provides additional strength
- Designed for difficult-to-drill alloy applications

Material Application: Steel, Stainless Steel

Item #	Code	Size (in.)	Decimal Equivalent	Flute Length (in.)	Overall Length (in.)	Stock*
C116	TRI	1/16	.0625	7/8	1 7/8	A
C564	TRI	5/64	.0781	1	2	A
C332	TRI	3/32	.0938	1 1/4	2 1/4	Y
C764	TRI	7/64	.1094	1 1/2	2 5/8	A
C18	TRI	1/8	.1250	1 5/8	2 3/4	Y
C964	TRI	9/64	.1406	1 3/4	2 7/8	Y
C532	TRI	5/32	.1562	2	3 1/8	Y
C1164	TRI	1 1/64	.1719	2 1/8	3 1/4	Y
C316	TRI	3/16	.1875	2 5/16	3 1/2	Y
C1364	TRI	13/64	.2031	2 7/16	3 5/8	Y
C732	TRI	7/32	.2188	2 1/2	3 3/4	Y
C1564	TRI	15/64	.2344	2 5/8	3 7/8	Y
C14-TRI	TRI	1/4	.2500	2 3/4	4	Y
C1764	TRI	17/64	.2656	2 7/8	4 1/8	Y
C932	TRI	9/32	.2812	2 15/16	4 1/4	A
C1964	TRI	19/64	.2969	3 1/16	4 3/8	A
C516	TRI	5/16	.3125	3 3/16	4 1/2	Y
C2164	TRI	21/64	.3281	3 5/16	4 5/8	A
C1132	TRI	1 1/32	.3438	1 7/16	4 3/4	Y
C2364	TRI	23/64	.3594	3 1/2	4 7/8	A
C38	TRI	3/8	.3750	3 5/8	5	Y
C2564	TRI	25/64	.3906	3 3/4	5 1/8	Y
C1332	TRI	13/32	.4062	3 7/8	5 1/4	A
C2764	TRI	27/64	.4219	3 15/16	5 3/8	Y
C716	TRI	7/16	.4375	4 1/16	5 1/2	Y
C2964	TRI	29/64	.4531	4 3/16	5 5/8	A
C1532	TRI	15/32	.4688	4 5/16	5 3/4	A
C3164	TRI	31/64	.4844	4 3/8	5 7/8	A
C12-TRI	TRI	1/2	.5000	4 1/2	6	Y



Screw Machine Drill: Stubby

- 135° split-point for quick penetration and reduced “walking”
- High Speed Steel with black oxide finish
- Short length and heavy-duty construction provides additional strength
- Performs well in a broad range of iron and steel materials

Material Application: Iron, Steel, Stainless Steel, Wood

Item #	Code	Size (in.)	Decimal Equivalent	Flute Length (in.)	Overall Length (in.)	Stock*
S364	TRI	3/64	.0469	1/2	1 3/8	A
S116	TRI	1/16	.0625	5/8	1 5/8	A
S564	TRI	5/64	.0781	1 1/16	1 11/16	Y
S332	TRI	3/32	.0938	3/4	1 3/4	A
S764	TRI	7/64	.1094	13/16	1 13/16	Y
S18	TRI	1/8	.1250	7/8	1 7/8	Y
S964	TRI	9/64	.1406	15/16	1 15/16	Y
S532	TRI	5/32	.1562	1	2 1/16	Y
S1164	TRI	1 1/64	.1719	1 1/16	2 1/8	Y
S316	TRI	3/16	.1875	1 1/8	2 3/16	Y
S1364	TRI	13/64	.2031	1 3/16	2 1/4	Y
S732	TRI	7/32	.2188	1 1/4	2 3/8	Y
S1564	TRI	15/64	.2344	1 5/16	2 7/16	Y
S14	TRI	1/4	.2500	1 3/8	2 1/2	Y
S1764	TRI	17/64	.2656	1 7/16	2 5/8	Y
S932	TRI	9/32	.2812	1 1/2	2 11/16	Y
S1964	TRI	19/64	.2969	1 9/16	2 3/4	Y
S516	TRI	5/16	.3125	1 5/8	2 13/16	Y
S2164	TRI	21/64	.3281	1 11/16	2 15/16	Y
S1132	TRI	1 1/32	.3438	1 11/16	3	Y
S2364	TRI	23/64	.3594	1 3/4	3 1/16	Y
S38	TRI	3/8	.3750	1 13/16	3 1/8	Y
S2564	TRI	25/64	.3906	1 7/8	3 1/4	Y
S1332	TRI	13/32	.4062	1 15/16	3 5/16	A
S2764	TRI	27/64	.4219	2	3 3/8	A
S716	TRI	7/16	.4375	2 1/16	3 7/16	A
S2964	TRI	29/64	.4531	2 1/8	3 9/16	A
S1532	TRI	15/32	.4688	2 1/8	3 5/8	A
S3164	TRI	31/64	.4844	2 3/16	3 11/16	A
S12	TRI	1/2	.5000	2 1/4	3 3/4	Y



Body Drill: Double End

- 135° split-point
- High Speed Steel with black oxide finish

Material Application: Thin Sheet Metal

Item #	Code	Size (in.)	Decimal Equivalent	Flute Length (in.)	Overall Length (in.)	Stock*
SD764	TRI	7/64	.1094	1/2	1 7/8	A
SD18	TRI	1/8	.1250	1/2	2	A
SD964	TRI	9/64	.1406	1/2	2	Y
SD532	TRI	5/32	.1562	1/2	2 1/16	A
SD316	TRI	3/16	.1875	1/2	2 3/16	Y
SD732	TRI	7/32	.2188	1/2	2 3/8	Y
SD14	TRI	1/4	.2500	1/2	2 1/2	Y

Drill Bits - Metal Drilling



THUNDERBIT™

Reduced Shank Drill: 3/8" Thunderbit

- 135° split-point for quick penetration and reduced "walking"
- Premium-grade M-7 industrial steel for longer life and heat resistance
- Black/bronze oxide finish
- Unique flute design for superior material removal
- Ideal for use in medium- and high-tensile strength alloy materials

Material Application: Iron, Steel, Stainless Steel, Wood

Item #	Code	Size (in.)	Decimal Equivalent	Flute Length (in.)	Overall Length (in.)	Stock*
092125	TRI	25/64	.3906	3 3/4	5 1/8	A
092126	TRI	13/32	.4062	3 7/8	5 1/4	A
092127	TRI	27/64	.4219	3 15/16	5 3/8	A
J716-38	TRI	7/16	.4375	4 1/16	5 1/2	Y
092129	TRI	29/64	.4531	4 3/16	5 5/8	A
092130	TRI	15/32	.4688	4 5/16	5 3/4	A
092131	TRI	31/64	.4844	4 3/8	5 7/8	A
J12-38	TRI	1/2	.5000	4 1/2	6	Y
J1732-38	TRI	17/32	.5312	2 3/4	5	A
J916-38	TRI	9/16	.5625	2 3/4	5	A
J58-38	TRI	5/8	.6250	2 3/4	5	A
J1116-38	TRI	11/16	.6875	2 3/4	5	A
J34-38	TRI	3/4	.7500	2 3/4	5	A

Reduced Shank Drill: 1/2", Silver & Deming

- 118° point, high-speed steel, black oxide flutes, round shank
- Not designed to enlarge existing holes
- Ideal for light- to intermediate-duty application

Material Application: Iron, Steel, Stainless Steel



Item #	Code	Size (in.)	Decimal Equivalent	Flute Length (in.)	Overall Length (in.)	Stock*
J3364	TRI	33/64	.5156	3	6	A
J1732	TRI	17/32	.5312	3	6	Y
J3564	TRI	35/64	.5469	3	6	A
J916	TRI	9/16	.5625	3	6	Y
J3764	TRI	37/64	.5781	3	6	A
J1932	TRI	19/32	.5938	3	6	A
J3964	TRI	39/64	.6094	3	6	A
J58	TRI	5/8	.6250	3	6	Y
J4164	TRI	41/64	.6406	3	6	A
J2132	TRI	21/32	.6562	3	6	A
J4364	TRI	43/64	.6719	3	6	A
J1116	TRI	11/16	.6875	3	6	Y
J4564	TRI	45/64	.7031	3	6	A
J2332	TRI	23/32	.7188	3	6	Y
J4764	TRI	47/64	.7344	3	6	A
J34	TRI	3/4	.7500	3	6	Y
J4964	TRI	49/64	.7656	3	6	A
J2532	TRI	25/32	.7812	3	6	A
J5164	TRI	51/64	.7969	3	6	A
J1316	TRI	13/16	.8125	3	6	Y
J5364	TRI	53/64	.8281	3	6	A
J2732	TRI	27/32	.8438	3	6	A
J5564	TRI	55/64	.8594	3	6	A
J78	TRI	7/8	.8750	3	6	Y

Item #	Code	Size (in.)	Decimal Equivalent	Flute Length (in.)	Overall Length (in.)	Stock*
091757	TRI	57/64	.8906	3	6	A
091758	TRI	29/32	.9062	3	6	A
J5964	TRI	59/64	.9219	3	6	A
J1516	TRI	15/16	.9375	3	6	Y
J6164	TRI	61/64	.9531	3	6	A
J3132	TRI	31/32	.9688	3	6	A
J6364	TRI	63/64	.9844	3	6	A
J1	TRI	1	1.0000	3	6	Y
J1-164	TRI	1 1/64	1.0156	3	6	A
J-132	TRI	1 1/32	1.0312	3	6	A
J1-364	TRI	1 3/64	1.0469	3	6	A
J1-116	TRI	1 1/16	1.0625	3	6	A
J1-332	TRI	1 3/32	1.0938	3	6	A
J1-18	TRI	1 1/8	1.1250	3	6	A
J1-532	TRI	1 5/32	1.1562	3	6	A
J1-316	TRI	1 3/16	1.1875	3	6	A
J1-732	TRI	1 7/32	1.2188	3	6	A
J114	TRI	1 1/4	1.2500	3	6	Y
J1-932	TRI	1 9/32	1.2812	3	6	A
J1-516	TRI	1 5/16	1.3125	3	6	A
J1-38	TRI	1 3/8	1.3750	3	6	A
J1-716	TRI	1 7/16	1.4375	3	6	A
J1-12	TRI	1 1/2	1.5000	3	6	A

Drill Bits - Metal Drilling



Titanium-Coated Step Drill Bit

- Titanium coating lasts up to six times longer than high speed steel
- Balance double flute eliminates chatter and vibration
- Resharpenable cutting edge provides longer tool life
- Three-flat shank for reduced slippage



Item #	Code	Diameter (increments)	Step Depth	No. of Hole Sizes	Shank Diameter	Stock*
SDT1	BOS	1/8"-1/2" (1/32")	1/8"	13	1/4"	Y
SDT2	BOS	3/16"-7/8" (1/16")	1/8"	12	3/8"	Y
SDT4	BOS	1/4"-7/8"-1 1/8"	5/32"	3	3/8"	Y
SDT5	BOS	7/8"	—	1	3/8"	Y
SDT7	BOS	9/16"-1" (1/16")	1/8"	8	3/8"	Y
SDT10	BOS	1/4"-1 3/8" (1/8")	1/8"	10	3/8"	Y
SDT11	BOS	1 1/8"	—	1	1/2"	Y
SDT30	BOS	3-Piece Step Drill Set includes: SDT1 - 1/8"-1/2" (1/32") SDT3 - 1/4"-3/4" (1/16") SDT6 - 3/16"-1/2" (1/16")				Y



Drill Bit Sharpener

Sharpens the largest range of dull or broken bits, including split points and masonry bits.

- One chuck sharpens all sizes 3/32" to 3/4"
- Sharpens High Speed Steel, carbide, cobalt, TiN-coated and masonry bits
- Custom point angle sharpening—choose any angle from 115°-140°

Item #	Code	Description	Stock*
DD750X	TRI	Drill Bit Sharpener	Y



Titanium Coated Countersink

Item #	Code	Diameter	Chamfer Angle	No. of Flutes	Shank Diameter	Stock*
CST1	BOS	1/2"	82°	13	1/4"	Y
CST2-BOS	BOS	5/8"	82°	12	3/8"	Y
CST3	BOS	3/4"	82°	3	3/8"	Y



Center Reamer/Countersink

- 82° point, High Speed Steel, black oxide
- Used for centering lathe work on predrilled holes or countersinking for screw heads

Item #	Code	Size (in.)	Shank Diameter (in.)	Overall Length (in.)	Stock*
039416	TRI	1/4	3/16	1 1/2	A
039417	TRI	3/8	1/4	1 3/4	A
039418	TRI	1/2	3/8	2	Y
039419	TRI	5/8	3/8	2 1/4	A
039420	TRI	3/4	1/2	2 5/8	Y
039464	TRI	1	1/2	3	A



Car Reamer

- 1/2" Shank, High Speed Steel, black oxide
- Three-flats on shank prevents slippage in three-jaw chuck
- Engineered exclusively to enlarge and align existing holes
- Ideal for maintenance and repair

Item #	Code	Size (in.)	Decimal Equivalent	Shank Dia. (in.)	# of Flutes	Flute Length (in.)	Overall Length (in.)	Stock*
072280	TRI	3/8	.3750	3/8	4	3	5	A
072281	TRI	1/2	.5000	1/2	5	3 15/16	5 15/16	A
072282	TRI	9/16	.5625	1/2	5	3 15/16	5 15/16	A
072283	TRI	5/8	.6250	1/2	5	4 1/2	6 9/16	Y
072284	TRI	1 1/16	.6875	1/2	5	4 1/2	6 9/16	A
072285	TRI	3/4	.7500	1/2	5	4 15/16	7	Y
072286	TRI	13/16	.8125	1/2	5	4 15/16	7	A
072287	TRI	7/8	.8750	1/2	5	5 3/16	7 1/4	A
072288	TRI	15/16	.9375	1/2	5	5 3/16	7 1/4	A
072289	TRI	1	1.0000	1/2	5	5 3/16	7 1/4	A

*Y = stock item; A = readily available by order

Drill Bits - Metal Drilling



Black Oxide Drill Bit Set

20-piece set contains:

- (2) 1/16", (2) 5/64", (2) 3/32", (2) 7/64", (1) 1/8", (1) 9/64", (1) 5/32", (1) 11/64", (2) 3/16", (1) 7/32", (1) 1/4", (1) 5/16", (1) 3/8", (1) 1/2"
- Brute Tough™ Case



Item #	Code	Description	Stock*
BL20	BOS	20-Pc. Black Oxide Drill Bit Set	Y

Titanium Coated Drill Bit Set

15-piece set contains:

- (2) 1/16", (2) 5/64", (1) 3/32", (2) 7/64", (2) 1/8", (1) 9/64", (1) 5/32", (1) 11/64", (1) 3/16", (1) 7/32", (1) 1/4", (1) 5/16", (1) 3/8", (1) 1/2"
- Brute Tough™ Case



Item #	Code	Description	Stock*
T118	BOS	15-Pc. Titanium Coated Drill Bit Set	Y

Drill and Drive Set - Metal & Wood

39-piece set contains:

- Titanim drill bits: (2) 1/16", (1) 5/64", (1) 3/32", (1) 7/64", (2) 1/8", (1) 9/64", (1) 5/32", (1) 11/64", (1) 3/16", (1) 7/32", (1) 1/4"
- Insert bits: (5) P2+R2, (1) #1, (1) #2, (1) #3, (1) 6-8, (1) 8-10, (1) 10-12, (1) T15, (1) T20, (1) T25, (1) R1, (1) R2, (1) R3
- DareDevil® spade bits (one each): 1/2", 3/4", 1"
- Magnetic nut setters (one each): 1/4", 5/16"
- Finder-Driver
- Case



Item #	Code	Description	Stock*
T4039	BOS	39-Piece Drill/Drive Set	Y

*Y = stock item; A = readily available by order



Taps & Dies



Hex Die

- Carbon steel with bright finish
- Use with ratchets or adjustable wrenches



Item #	Code	Size/Pitch	Thread**	Across Flats	Stock*
6-32DIE	TRI	6-32	NC	1	Y
8-32DIE	TRI	8-32	NC	1	Y
10-24DIE	TRI	10-24	NC	1	Y
10-32DIE	TRI	10-32	NF	1	Y
14-20DIE	TRI	1/4-20	NC	1	Y
14-28DIE	TRI	1/4-28	NF	1	Y
516-18DIE	TRI	5/16-18	NC	1	Y
516-24DIE	TRI	5/16-24	NC	1	Y
38-16DIE	TRI	3/8-16	NC	1	Y
38-24DIE	TRI	3/8-24	NF	1	Y
716-14DIE	TRI	7/16-14	NC	1	Y
716-20DIE	TRI	7/16-20	NF	1	Y
12-13DIE	TRI	1/2-13	NC	1	Y
12-20DIE	TRI	1/2-20	NF	1	Y
T18NPTDIE	TRI	1/8-27	NPT	1	Y
58-11DIE	TRI	5/8-11	NC	1-7/16	Y
58-18DIE	TRI	5/8-18	NF	1-7/16	Y
34-16DIE	TRI	3/4-16	NF	1-7/16	Y

**NC = National Course; NF = National Fine; NS = National Special; NPT = National Pipe Thread

Don't forget about...



...Safety!

Taps & Dies

THUNDER TAP



Straight Flute Hand Tap - Taper, Plug and Bottoming

- High Speed Steel and bronze oxide finish
- Chamfer: Taper (7–10 threads long), Plug (3–5 threads long), Bottoming (1–2 threads long)

Size/Pitch	Thread**	GH	# of Flutes	Drill Size	Taper Item #	Stock*	Plug Item #	Stock*	Bottoming Item #	Stock*	Code
4-40	NC	H2	3	43	071040	A	071090	A	071140	A	TRI
6-32	NC	H3	3	36	6-32T	Y	071091	A	071141	A	TRI
6-40	NF	H2	3	33	—	—	—	—	071092	A	TRI
8-32	NC	H3	4	29	8-32T	Y	8-32P	Y	071143	A	TRI
8-36	NF	H2	4	29	—	—	—	—	071094	A	TRI
10-24	NC	H3	4	25	10-24T	Y	071095	A	071145	A	TRI
10-32	NF	H3	4	21	10-32T	Y	071096	A	071146	A	TRI
12-24	NC	H3	4	16	12-24T	Y	12-24P	Y	12-24B	Y	TRI
12-28	NF	H3	4	15	—	—	—	—	071098	A	TRI
1/4-20	NC	H3	4	7	14-20T	Y	071060	A	14-20B	Y	TRI
1/4-28	NF	H3	4	3	14-28T	Y	071061	A	071101	A	TRI
5/16-18	NC	H3	4	F	516-18T	Y	071062	A	516-18B	Y	TRI
5/16-24	NF	H3	4	I	516-24T	Y	071063	A	071103	A	TRI
3/8-16	NC	H3	4	5/16	38-16T	Y	071064	A	38-16B	Y	TRI
3/8-24	NF	H3	4	Q	38-24T	Y	071065	A	071105	A	TRI
7/16-14	NC	H3	4	U	716-14T	Y	071066	A	071106	A	TRI
7/16-20	NF	H3	4	25/64	071007	A	716-20P	Y	071107	A	TRI
1/2-13	NC	H3	4	27/64	12-13T	Y	12-20P	A	12-13B	Y	TRI
1/2-20	NG	H3	4	29/64	12-20T	Y	071069	Y	071109	A	TRI
9/16-12	NC	H3	4	31/64	071010	A	071070	A	071110	A	TRI
9/16-18	NF	H3	4	33/64	071011	A	071071	A	071111	A	TRI
5/8-11	NC	H3	4	17/32	58-11T	Y	071072	A	071112	A	TRI
5/8-18	NF	H3	4	37/64	58-18T	Y	071073	A	071113	A	TRI
3/4-10	NC	H3	4	21/32	34-10T	Y	071074	A	071114	A	TRI
3/4-16	NF	H3	4	11/16	34-16T	Y	071075	A	071115	A	TRI
7/8-9	NC	H4	4	49/64	071016	A	071076	A	071116	A	TRI
7/8-14	NF	H4	4	13/16	78-14T	Y	071077	A	071117	A	TRI
1-8	NC	H4	4	7/8	071018	A	071078	A	071118	A	TRI
1-12	NF	H4	4	59/64	071019	A	071079	A	071119	A	TRI
1 1/8-7	NC	H4	4	63/64	071020	A	071080	A	071120	A	TRI

**NC = National Course; NF = National Fine

Tap Wrench

- Sliding T-handle is ideal for turning in confined areas
- Strong and rugged for easy handling and accurate tapping

Item #	Code	Capacity	Handle	Stock*
069902	TRI	0 to 1/4	T-Handle	A
JT30	TRI	12 to 5/16	T-Handle	Y
069904	TRI	1/4 to 1/2	T-Handle	A
069900	TRI	0 to 3/16	Straight	A
JTW5	TRI	10 to 1/2	Straight	A
069907	TRI	3/8 to 1	Straight	A

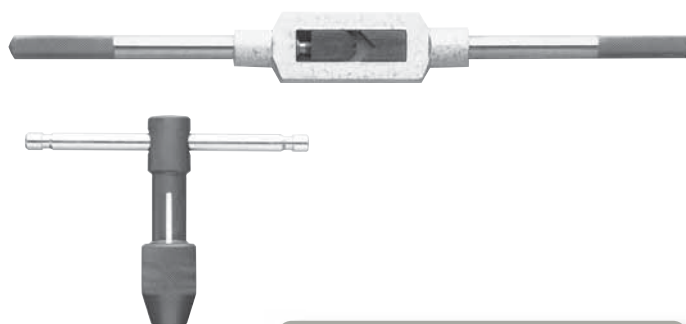

*Y = stock item; A = readily available by order

Burs

Carbide Bur

Accu-Tool solid carbide burs are manufactured in the U.S.A. from high performance, industrial grade carbide to give long life and exceptional performance in the most demanding applications. These burs have double-cut flutes with 1/4" shanks.



Round Tree Shape

Item #	Code	Dia.	LOF	Stock*
SF-1	ABR	1/4"	5/8"	A
SF-3	ABR	3/8"	3/4"	A
SF-4	ABR	7/16"	1"	A
SF-13	ABR	1/2"	3/4"	A
SF5	ABR	1/2"	1"	Y
SF-6	ABR	5/8"	1"	A
SF-7	ABR	3/4"	1"	A
SF-14	ABR	3/4"	1 1/4"	A
SF-15	ABR	3/4"	1 1/2"	A



14° Taper-Radius End

Item #	Code	Dia.	LOF	Stock*
SL1	ABR	1/4"	5/8"	Y
SL-2	ABR	5/16"	7/8"	A
SL3	ABR	3/8"	1 1/16"	Y
SL4	ABR	1/2"	1 1/8"	Y
SL-6	ABR	5/8"	1 5/16"	Y
SL-7	ABR	3/4"	1 1/2"	A



Cylindrical Radius End

Item #	Code	Dia.	LOF	Stock*
SC-12	ABR	1/8"	5/8"	A
SC-14	ABR	3/16"	5/8"	A
SC1	ABR	1/4"	5/8"	Y
SC-1A	ABR	1/4"	1"	A
SC-2	ABR	5/16"	3/4"	A
SC-3	ABR	3/8"	3/4"	A
SC-3A	ABR	3/8"	1"	A
SC-4	ABR	7/16"	1"	A
SC5	ABR	1/2"	1"	Y
SC-6	ABR	5/8"	1"	A
SC-7	ABR	3/4"	1"	A



Cone Shape

Item #	Code	Dia.	LOF	Stock*
SM-1	ABR	1/4"	1/2"	A
SM-2	ABR	1/4"	3/4"	A
SM-3	ABR	1/4"	1"	A
SM4	ABR	3/8"	5/8"	Y
SM-5	ABR	1/2"	7/8"	A
SM-6	ABR	5/8"	1"	A



Oval Shape

Item #	Code	Dia.	LOF	Stock*
SE-11	ABR	3/16"	5/16"	A
SE-1	ABR	1/4"	3/8"	A
SE-3	ABR	3/8"	3/8"	A
SE5	ABR	1/2"	7/8"	Y
SE-6	ABR	5/8"	1"	A
SE-7	ABR	3/4"	1"	A



Cylindrical - End Cut

Item #	Code	Dia.	LOF	Stock*
SA-12	ABR	1/8"	5/8"	A
SA-14	ABR	3/16"	5/8"	A
SA1	ABR	1/4"	5/8"	Y
SA-1A	ABR	1/4"	1"	A
SA-2	ABR	5/16"	3/4"	A
SA-3	ABR	3/8"	3/4"	A
SA-3A	ABR	3/8"	1"	A
SA-4	ABR	7/16"	1"	A
SA5	ABR	1/2"	1"	Y
SA-6	ABR	5/8"	1"	A
SA-16	ABR	3/4"	3/4"	A
SA-7	ABR	3/4"	1"	A
SA-9	ABR	1"	1"	A



Flame Shape

Item #	Code	Dia.	LOF	Stock*
SH-1	ABR	1/4"	1/2"	A
SH-2	ABR	5/16"	3/4"	A
SH5	ABR	1/2"	1 1/4"	Y
SH-6	ABR	5/8"	1 7/16"	A
SH-7	ABR	3/4"	1 5/8"	A

Accu-Tool

Miniature Carbide Bur - Series 40

- 1/16" - 1/18" diameter head
- 1 1/2" overall length.
- 1/8" diameter solid carbide shank.



Item #	Code	Size	Stock*
SB43	ABR	1/8" x 9/16"	Y
SB-41 ECO	ABR	1/8"	A
SD-42	ABR	1/8" x 1/8"	A
SH-41	ABR	1/8" x 1/4"	A
SG-41	ABR	1/8" x 1/4"	Y
SM-43	ABR	1/8" x 5/8"	A
7°, incl. taper			
SL-42	ABR	1/8" x 1/2"	A
8°, incl. taper			
SA-42	ABR	3/32" x 7/16"	A
SC42	ABR	1/8" x 9/16"	Y
SD-41	ABR	3/32" x 3/32"	A
SF-42	ABR	1/8" x 1/2"	A
SM42	ABR	1/8" x 7/16"	Y
14°, incl. taper			
SL-41	ABR	1/8" x 3/8"	A
8°, incl. taper			
SN-42	ABR	1/8" x 3/16"	A
10°, incl. taper			
SA-41	ABR	1/16" x 1/4"	A
SC-41	ABR	3/32" x 7/16"	A
SE41	ABR	1/8" x 7/32"	Y
SG-43	ABR	1/8" x 3/8"	A
SF-41	ABR	1/8" x 1/4"	A
SM-41	ABR	1/8" x 11/32"	Y
12°, incl. taper			
SJ-42	ABR	1/8" x 3/32"	A
60°, incl. taper			
SN-41	ABR	3/32" x 1/8"	A
10°, incl. taper			

*Y = stock item; A = readily available by order

Burs

Aluminum Cut Bur

Accu-Tool

Item #	Code	Stock*	
SA1-NF	ABR	Y	
SA-3-NF	ABR	A	
SA-5-NF	ABR	A	
SA-6-NF	ABR	A	
SC-1-NF	ABR	Y	
SC-3-NF	ABR	A	
SC-5-NF	ABR	A	
SD-1-NF	ABR	A	
SD-3-NF	ABR	Y	
SD-5-NF	ABR	A	
SD-6-NF	ABR	A	
SE-3-NF	ABR	A	
SE5-NF	ABR	Y	
SE-6-NF	ABR	A	
SF-1-NF	ABR	A	
SF-3-NF	ABR	A	
SF-5-NF	ABR	A	
SF-6-NF	ABR	A	
SL-3-NF	ABR	A	
SL-4-NF	ABR	Y	
SL-6-NF	ABR	A	



4.5 Amp
Die Grinder
see page 41



*Y = stock item; A = readily available by order

Annular Cutters

Annular cutters are a more efficient way to cut a hole through steel than using a twist drill. Annular cutters remove only a narrow wall of material, leaving behind a slug of material that is ejected at the end of the cut. When compared to a twist drill, annular cutters use far less energy and time to do the same work.



Cobalt M35 Cutter

Code	Diameter (Inches)	1"	Stock*	2"	Stock*	3"	Stock*
UDC	7/16	25114	A	25214	A		
UDC	1/2	25116	Y	25216	A		
UDC	9/16	25118	A	25218-UDC	Y		
UDC	5/8	25120	Y	25220	A		
UDC	11/16	25122	Y	25222	Y		
UDC	3/4	25124	Y	25224	A	25324	A
UDC	13/16	25126	Y	25226	A	25326	A
UDC	7/8	25128	Y	25228	A	25328	A
UDC	15/16	25130	Y	25230	A	25330	A
UDC	1	25132	Y	25232	A	25332	A
UDC	1 1/16	25134	A	25234	A	25334	A
UDC	1 1/8	25136	A	25236	Y	25336	Y
UDC	1 3/16	25138	A	25238	A	25338	A
UDC	1 1/4	25140	A	25240	A	25340	A
UDC	1 5/16	25142	A	25242	A	25342	A
UDC	1 3/8	25144	A	25244	A	25344	A
UDC	1 7/16	25146	A	25246	A	25346	A
UDC	1 1/2	25148	A	25248	A	25348	A
UDC	1 9/16	25150	A	25250	A	25350	A
UDC	1 5/8	25152	A	25252	A	25352	A
UDC	1 11/16	25154	A	25254	A	25354	A
UDC	1 3/4	25156	A	25256	A	25356	A
UDC	1 13/16	25158	A	25258	A	25358	A
UDC	1 7/8	25160	A	25260	A	25360	A
UDC	1 15/16	25162	A	25262	A	25362	A
UDC	2	25164	A	25264	A	25364	A
UDC	2 1/16	25166	A	25266	A	25366	A
UDC	2 1/8	25168	A	25268	A	25368	A
UDC	2 3/16	25170	A	25270	A	25370	A
UDC	2 1/4	25172	A	25272	A	25372	A
UDC	2 5/16	25174	A	25274	A	25374	A
UDC	2 3/8	25176	A	25276	A	25376	A
UDC	2 7/16	25178	A	25278	A	25378	A
UDC	2 1/2	25180	A	25280	A	25380	A
UDC	2 9/16	25182	A	25282	A	25382	A
UDC	2 5/8	25184	A	25284	A	25384	A
UDC	2 11/16	25186	A	25286	A	25386	A
UDC	2 3/4	25188	A	25288	A	25388	A
UDC	2 13/16	25190	A	25290	A	25390	A
UDC	2 7/8	25192	A	25292	A	25392	A
UDC	2 15/16	25194	A	25294	A	25394	A
UDC	3	25196	A	25296	A	25396	A
UDC	Pilot Pins	USP-1	S	USP-2	S	USP-3	S
UDC	Use Special Pilot Pins	USP-1A	A	USP-2A	A		

Drill Bits - Concrete Drilling

SDS-plus® Bulldog™ Xtreme Rotary Hammer Carbide Bit

- Diffusion bonding technology provides stronger carbide bond for a longer-lasting bit
- Flute design runs cooler with fast dust removal; optimizing flute cross section reduces stress
- Wear mark assures accuracy of hole diameter
- Centric active tip guides bit through concrete and provides rounder holes
- Solid carbide head tip drills faster with less carbide wear

Item #	Code	Diameter (Inches)	Usable Length (Inches)	Overall Length (Inches)	Stock*
HCFC2010	BOS	3/16	2	4	Y
HCFC2011	BOS	3/16	4	6 1/2	Y
HCFC2012	BOS	3/16	6	8 1/2	Y
HCFC2014	BOS	3/16	10	2	Y
HCFC2040	BOS	1/4	2	4	Y
HCFC2041	BOS	1/4	4	6 1/2	Y
HCFC2042	BOS	1/4	6	8 1/2	Y
HCFC2044	BOS	1/4	10	12	Y
HCFC2051	BOS	5/16	4	6	Y
HCFC2054	BOS	5/16	10	12	Y
HCFC2061	BOS	3/8	4	6	Y
HCFC2064	BOS	3/8	10	12	Y
HCFC2067	BOS	3/8	16	18	Y
HCFC2081	BOS	1/2	4	6	Y
HCFC2084	BOS	1/2	10	12	Y
HCFC2087	BOS	1/2	16	18	Y



SDS-plus® Bulldog™ Hex Drive Accessories and Kit

For use with masonry fastening systems/hex sleeve drive tools. Hex drive on bit fits into driver sleeve.

- 1/4" hex shoulder for drive sleeve used to set masonry screws



HC2309



HC2302

Item #	Code	Diameter (Inches)	Usable Length (Inches)	Overall Length (Inches)	Stock*
HC2302	BOS	5/32	4	7	Y
HC2309	BOS	7-Piece Anchor Drive Installation Kit: 5/32" x 6 1/2" and 3/16" x 6 1/2" hex bits, #2 and #3 Phillips power bits, 5 3/4" sleeve, 1/4" and 5/16" sockets			Y



SDS-plus® Bulldog™ Rotary Hammer Carbide Bit

- Optimized brazing and hardening process for long life
- Optimized flute design to reduce bit stress and make the bit run cooler
- Centric tip for optimal hole geometry



HCK001



Item #	Code	Diameter (Inches)	Usable Length (Inches)	Overall Length (Inches)	Stock*
HC2001	BOS	5/32	4	6	Y
HC2010	BOS	3/16	2	4	Y
HC2010B25	BOS	Bulk Quantity of #HC2010 - 25/pack			Y
HC2011	BOS	3/16	4	6	Y
HC2012	BOS	3/16	6	8	Y
HC2013	BOS	3/16	10	8	Y
HC2014	BOS	3/16	10	12	Y
HC2015	BOS	3/16	12	14	Y
HC2032	BOS	7/32	6	8	Y
HC2034	BOS	3/16	10	2	Y
HC2040	BOS	1/4	2	4	Y
HC2042	BOS	1/4	6	8	Y
HC2045	BOS	1/4	10	12	Y
HC2051	BOS	5/16	4	6	Y
HC2054	BOS	5/16	10	12	Y
HC2061	BOS	3/8	4	6	Y
HC2064	BOS	3/8	10	12	Y
HC2067	BOS	3/8	16	18	Y
HC2068	BOS	3/8	22	24	Y
HC2071	BOS	7/16	4	6	Y
HC2074	BOS	7/16	10	12	Y
HC2081	BOS	1/2	4	6	Y
HC2084	BOS	1/2	10	12	Y
HC2087	BOS	1/2	16	18	Y
HC2088	BOS	1/2	22	24	Y
HC2091	BOS	9/16	4	6	Y
HC2102	BOS	5/8	6	8	Y
HC2104	BOS	5/8	10	12	Y
HC2107	BOS	5/8	16	18	Y
HC2112	BOS	1 1/16	6	8	Y
HC2124	BOS	3/4	10	12	Y
HC2127	BOS	3/4	16	18	Y
HC2142	BOS	7/8	6	8	Y
HC2147	BOS	7/8	16	18	Y
HC2163	BOS	1	8	10	Y
HC2167	BOS	1	16	18	Y
HCK001	BOS	7-Piece Carbide Hammer Drill Kit: (1) 3/16" x 2" x 4", (1) 1/4" x 2" x 4", (2) 1/4" x 4" x 6", (1) 5/16" x 4" x 6", (1) 3/8" x 4" x 6", (1) 1/2" x 4" x 6", Brute Tough case			Y

Drill Bits - Concrete Drilling

Spline SpeedX™ Rotary Hammer Carbide Bit

- Carbide tipped

Item #	Code	Diameter (Inches)	Usable Length (Inches)	Overall Length (Inches)	Stock*
HC4021	BOS	5/8	8	13	Y
HC4022	BOS	5/8	16	21	Y
HC4024	BOS	5/8	31	36	Y
HC4031	BOS	3/4	8	13	Y
HC4032	BOS	3/4	16	21	Y
HC4033	BOS	3/4	24	29	Y
HC4040	BOS	7/8	8	13	Y
HC4041	BOS	7/8	16	21	Y
HC4043	BOS	7/8	31	36	Y
HC4050	BOS	1	8	13	Y
HC4051	BOS	1	16	21	Y
HC4053	BOS	1	31	36	Y
HC4061	BOS	1 1/8	16	21	Y
HC4070	BOS	1 1/4	8	13	Y
HC4071	BOS	1 1/8	16	21	Y
HC4081	BOS	1 3/8	16	21	Y
HC4091	BOS	1 1/2	16	21	Y
HC4501 2-Cutter Bit	BOS	3/8	8	13	Y
HC4511 2-Cutter Bit	BOS	1/2	8	13	Y
HC4512 2-Cutter Bit	BOS	1/2	16	21	Y
HC4513 2-Cutter Bit	BOS	1/2	24	29	Y
HC4516 2-Cutter Bit	BOS	9/16	16	21	Y



SDS-max® SpeedX™ Rotary Hammer Carbide Bit

- Wear mark indicator assures accuracy of hole diameter
- Inclined side cutters provide fast concrete drilling
- Compact head for fast dust removal and longer life
- Active centering tip provides quick accurate starts
- Solid carbide with robust S-cutter design for added speed and life
- Manufactured to ANSI specification B212.14

Item #	Code	Diameter (Inches)	Usable Length (Inches)	Overall Length (Inches)	Stock*
HC5005 2-Cutter Bit	BOS	3/8	8	13	Y
HC5010 2-Cutter Bit	BOS	1/2	8	13	Y
HC5011	BOS	1/2	16	21	Y
HC5020	BOS	5/8	8	13	Y
HC5021	BOS	5/8	16	21	Y
HC5030	BOS	1/4	8	13	Y
HC5031	BOS	3/4	16	21	Y
HC5040	BOS	7/8	8	13	Y
HC5041	BOS	7/8	16	21	Y
HC5050	BOS	1	8	13	Y
HC5051	BOS	1	16	21	Y



BlueGranite™ Turbo Carbide Hammer Drill Bit

- Various useable lengths up to 10"
- Milled u-flutes with deep-cut spiral for fast dust removal
- PowerGrip™ shank for aggressive gripping power
- Diamond ground carbide tip for precise starts in tile and hard stone
- Robust head provides long life in impact applications



HCBG700



HCBG600T

HCBG500

Item #	Code	Diameter (Inches)	Usable Length (Inches)	Overall Length (Inches)	Stock*
HCBG01	BOS	1/8	2	3	Y
HCBG03	BOS	3/16	3	4	Y
HCBG04	BOS	3/16	4	6	Y
HCBG06	BOS	1/4	4	6	Y
HCBG09	BOS	5/16	4	6	Y
HCBG12	BOS	3/8	4	6	Y
HCBG15	BOS	7/16	4	6	Y
HCBG16	BOS	1/2	4	6	Y
HCBG18	BOS	1/2	10	12	Y
HCBG22	BOS	3/4	4	6	Y
HCBG500	BOS	5-Piece Carbide Hammer Drill Kit: (1) 1/8" x 2" x 3", (1) 3/16" x 4" x 6", (1) 1/4" x 4" x 6", (1) 5/16" x 4" x 6", (1) 3/8" x 4" x 6", pouch			Y
HCBG600T	BOS	6-Piece Carbide Hammer Drill Kit: (3) 5/32" x 4" x 6", (3) 3/16" x 4" x 6", pouch			Y
HCBG700	BOS	7-Piece Carbide Hammer Drill Kit: (1) 1/8" x 2" x 3", (2) 5/32" x 3" x 6", (2) 3/16" x 4" x 6", (1) 1/4" x 4" x 6", (1) 3/8" x 4" x 6", Brute Tough case			Y



Drill Bits - Concrete Drilling



Spline Carbide Drill Bit

Spline carbide drill bits are designed for use in a rotary hammer equipped with a spline-type chuck. Bits are manufactured to conform with ANSI Standard B212.15 and can be used to drill in concrete, block, brick and soft stone.

Item #	Code	Size (inches)	Usable Length (in.)	Stock*
1401-POW	POW	3/8 x 8	3	A
1402-POW	POW	3/8 x 10	6	Y
1403-POW	POW	3/8 x 16	11	Y
1405-POW	POW	7/16 x 13	8	A
1407-POW	POW	1/2 x 10	5	Y
1408-POW	POW	1/2 x 13	8	Y
1409-POW	POW	1/2 x 16	11	Y
1410-POW	POW	1/2 x 22	18	Y
1412-POW	POW	1/2 x 27	22	Y
1413-POW	POW	1/2 x 36	31	A
1415-POW	POW	9/16 x 13	8	Y
1418-POW	POW	5/8 x 10	6	A
1419-POW	POW	5/8 x 13	8	A
1420-POW	POW	5/8 x 16	11	Y
1421-POW	POW	5/8 x 22	18	Y
1423-POW	POW	5/8 x 27	22	A
1424-POW	POW	5/8 x 36	31	Y
1427-POW	POW	11/16 x 13	8	Y
1431-POW	POW	3/4 x 10	6	A
1433-POW	POW	3/4 x 16	11	Y
1434-POW	POW	3/4 x 22	18	Y
1436-POW	POW	3/4 x 27	22	Y
1437-POW	POW	3/4 x 36	31	A
1443-POW	POW	7/8 x 16	11	Y
1444-POW	POW	7/8 x 22	18	Y
1446-POW	POW	7/8 x 36	31	Y
1449-POW	POW	1 x 16	11	Y
1450-POW	POW	1 x 22	18	Y
1453-POW	POW	1 x 36	31	Y
1457-POW	POW	1 1/8 x 16	11	Y
1458-POW	POW	1 1/8 x 22	18	A
1464-POW	POW	1 1/4 x 16	11	Y
1465-POW	POW	1 1/4 x 22	18	Y
1470-POW	POW	1 3/8 x 16	11	A
1471-POW	POW	1 3/8 x 22	18	Y
1477-POW	POW	1 1/2 x 22	18	Y
1482-POW	POW	1 5/8 x 22	18	A
1486-POW	POW	1 3/4 x 23	18	A
1490-POW	POW	2 x 22	18	Y



Wedge-Bit™ Carbide Drill Bit

For proper performance, Wedge-Bit® anchors must be installed with a Wedge-Bit. The Wedge-Bit has a special matched tolerance range designed to provide optimum performance for the anchor.

SDS-Plus® Wedge-Bit

Item #	Code	Size (inches)	Usable Length (in.)	Stock*
WB1314	POW	1/4 x 6	4	Y
WB1316	POW	3/8 x 6	4	Y
WB1318	POW	3/8 x 8	6	Y
WB1320	POW	1/2 x 6	4	Y
WB1322	POW	1/2 x 10	8	Y
WB1334	POW	1/2 x 12	10	Y
WB1324	POW	5/8 x 8	6	Y
WB1328	POW	3/4 x 8	6	Y
WB1330	POW	3/4 x 12	10	Y

Spline Wedge-Bit

Item #	Code	Size (inches)	Usable Length (in.)	Stock*
WB1340	POW	1/2 x 13	8	Y
WB1344	POW	5/8 x 13	8	Y

Straight Shank Wedge-Bit

Item #	Code	Size (inches)	Usable Length (in.)	Stock*
WB1372	POW	1/4 x 6	4	Y
WB1380	POW	3/8 x 6	4	Y
WB1390	POW	1/2 x 5	4	Y
WB1394	POW	1/2 x 13	11	Y

YOUR SATISFACTION IS GUARANTEED!

*Y = stock item; A = readily available by order

Rebar Cutter Bit

Rebar cutter bits provide a quick, easy method for drilling through mesh or reinforcing bars embedded in concrete when the drilled hole cannot be located. The bits are used in the rotation-only mode and are designed to fit in a standard rotary drill motor with a 1/2" Jacobs-type chuck.

When drilling with a hammer drill or rotary hammer, it is important to stop drilling immediately when a standard carbide bit contacts steel reinforcing bar or wire mesh, otherwise the bit will fail.

If the drilled hole cannot be relocated, a rebar cutter bit is used to drill through the embedded steel. Insert the rebar cutter into the chuck of a standard 1/2" rotary drill. Place the bit into the partially drilled hole until it contacts the mesh or reinforcing bar. Drill through the embedded steel with the rebar cutter bit. Once the bit has drilled through the steel, remove the debris from the hole, then continue drilling with the standard carbide tipped bit using a hammer drill or rotary hammer.

Item #	Code	Size (inches)	Usable Length (inches)	Stock*
0845	POW	1/2 x 12	11	Y
0844	POW	9/16 x 12	11	A
0846	POW	5/8 x 12	11	Y
0847	POW	11/16 x 12	11	A
0849	POW	3/4 x 12	11	Y
0851	POW	7/8 x 12	11	A
0853	POW	1 x 12	11	Y
0855	POW	1 1/4 x 12	11	A



SDS-plus® Carbide Rebar Cutter

- Unique flute geometry with steep spiral removes debris fast
- Relief hole dissipates heat and allows for slug removal

Item #	Code	Size (inches)	Stock*
RC2064	BOS	3/8 x 12	Y
RC2084	BOS	1/2 x 12	Y
RC2094	BOS	9/16 x 12	Y
RC2104	BOS	5/8 x 12	Y
RC2124	BOS	3/4 x 12	Y
RC2144	BOS	7/8 x 12	Y
RC2164	BOS	1 x 12	Y
RC2168	BOS	1 1/8 x 12	Y
RC2172	BOS	1 1/4 x 12	Y
RC2176	BOS	1 1/2 x 12	Y



Drill Bits - Concrete Drilling



SDS-Plus® Carbide Drill Bit

SDS-Plus carbide drill bits are designed for use in a rotary hammer equipped with an SDS-type chuck. These bits are manufactured to conform with ANSI Standard B212.15 and can be used to drill in concrete, block, brick and soft stone.



Item #	Code	Size (inches)	Usable Length (inches)	Stock*
302-POW	POW	5/32 x 6	4	Y
304-POW	POW	3/16 x 4	2	Y
306-POW	POW	3/16 x 6	4	Y
308-POW	POW	3/16 x 8	6	Y
310-POW	POW	3/16 x 10	8	Y
312-POW	POW	3/16 x 12	10	Y
314-POW	POW	3/16 x 14	12	Y
316-POW	POW	7/32 x 8	6	Y
317-POW	POW	7/32 x 11	9	A
318-POW	POW	7/32 x 14	12	A
319-POW	POW	7/32 x 16	14	Y
320-POW	POW	1/4 x 4	2	Y
321-POW	POW	1/4 x 6	4	Y
322-POW	POW	1/4 x 8	6	Y
323-POW	POW	1/4 x 11	9	Y
324-POW	POW	1/4 x 14	12	Y
325-POW	POW	1/4 x 16	14	Y
327-POW	POW	1/4 x 20	18	Y
329-POW	POW	5/16 x 6	4	Y
331-POW	POW	5/16 x 12	10	Y
333-POW	POW	3/8 x 6	4	Y
334-POW	POW	3/8 x 8	6	Y
336-POW	POW	3/8 x 12	10	Y
338-POW	POW	3/8 x 18	16	Y
339-POW	POW	3/8 x 24	22	Y

Item #	Code	Size (inches)	Usable Length (inches)	Stock*
341-POW	POW	7/16 x 6	4	Y
343-POW	POW	7/16 x 12	10	Y
346-POW	POW	1/2 x 6	4	Y
348-POW	POW	1/2 x 10	8	Y
349-POW	POW	1/2 x 12	10	Y
351-POW	POW	1/2 x 18	16	Y
352-POW	POW	1/2 x 24	22	Y
354-POW	POW	9/16 x 6	4	Y
355-POW	POW	9/16 x 10	8	A
359-POW	POW	5/8 x 8	6	Y
361-POW	POW	5/8 x 12	10	Y
362-POW	POW	5/8 x 18	16	Y
364-POW	POW	1 1/16 x 8	6	Y
365-POW	POW	1 1/16 x 12	10	A
368-POW	POW	3/4 x 8	6	Y
370-POW	POW	3/4 x 12	10	Y
371-POW	POW	3/4 x 18	16	Y
373-POW	POW	27/32 x 8	6	Y
375-POW	POW	7/8 x 8	6	Y
376-POW	POW	7/8 x 12	10	Y
377-POW	POW	7/8 x 18	16	Y
379-POW	POW	1 x 8	6	Y
380-POW	POW	1 x 10	8	Y
381-POW	POW	1 x 12	10	Y
382-POW	POW	1 x 18	16	Y

SDS-Max® Carbide Drill Bit

SDS-Max carbide drill bits are designed for use in a rotary hammer equipped with an SDS-Max-type chuck. These bits are manufactured to conform with ANSI Standard B212.15 and can be used to drill in concrete, block, brick and soft stone.



Item #	Code	Size (inches)	Usable Length (in.)	Stock*
8801	POW	1/2 x 13 1/2	8	Y
8802	POW	1/2 x 21 1/2	16	A
8805	POW	9/16 x 13 1/2	8	A
8806	POW	9/16 x 21 1/2	16	A
8809	POW	5/8 x 13 1/2	8	Y
8810-POW	POW	5/8 x 21 1/2	16	A
8812	POW	5/8 x 36 1/2	31	A
8815	POW	1 1/16 x 21 1/2	16	A
8817	POW	3/4 x 13 1/2	8	Y
8818	POW	3/4 x 21 1/2	16	Y
8820-POW	POW	3/4 x 36 1/4	31	A
8829	POW	7/8 x 13 1/4	8	A
8830-POW	POW	7/8 x 21 1/4	16	A
8833	POW	1 x 13 1/4	8	Y
8834	POW	1 x 21 1/4	16	A
8836-POW	POW	1 x 36 1/4	31	A
8843	POW	1 1/8 x 15	10	A
8844	POW	1 1/8 x 22 1/2	18	Y
8846	POW	1 1/4 x 15	10	A
8847	POW	1 1/4 x 22 1/2	18	Y
8848	POW	1 1/4 x 36 1/4	31	A
8853	POW	1 3/8 x 22 1/2	18	A
8859	POW	1 1/2 x 22 1/2	18	A



Tapper™ SDS Hex Carbide Drill Bit

Item #	Code	Size (inches)	Usable Length (in.)	Stock*
2793	POW	5/32 x 5	3	Y
2796	POW	3/16 x 5	3	Y
2797	POW	3/16 x 7	5	Y
5866	POW	1/4 x 6	4	Y



Spline Drive to SDS-plus® Adapter



Item #	Code	Description	Stock*
HA1020	BOS	Spline-SDS Adapter	Y

Drill Bits - Concrete Drilling



Heavy-Duty Straight Shank Carbide Drill Bit

Straight shank carbide drill bits are designed for use in a hammer drill equipped with a 3-jaw, Jacobs-type chuck. The bits meet ANSI standards and can be used to drill in concrete, block, brick and soft stone.

Item #	Code	Size (inches)	Usable Length (in.)	Shank Size (in.)	Stock*
0601	POW	1/8 x 3	2 1/4	1/8	Y
0604	POW	3/16 x 4	2 3/4	3/16	Y
0605	POW	3/16 x 6	4	3/16	Y
0612	POW	1/4 x 4	2 3/4	1/4	Y
0613	POW	1/4 x 6	4	1/4	Y
0614	POW	1/4 x 12	10	1/4	Y
0618	POW	5/16 x 4	2 3/4	1/4	Y
0619	POW	5/16 x 6	4	1/4	Y
0620	POW	5/16 x 12	10	1/4	Y
0621	POW	3/8 x 4	2	1/4	Y
0622	POW	3/8 x 6	4	1/4	Y
0623	POW	3/8 x 12	10	5/16	Y
0625	POW	3/8 x 24	22	5/16	Y



Item #	Code	Size (inches)	Usable Length (in.)	Shank Size (in.)	Stock*
0626	POW	7/16 x 6	4	3/8	Y
0631	POW	1/2 x 6	4	3/8	Y
0632	POW	1/2 x 12	10	3/8	Y
0635	POW	9/16 x 6	4	3/8	Y
0638	POW	5/8 x 6	4	3/8	Y
0640	POW	5/8 x 12	10	3/8	Y
0645	POW	3/4 x 6	4	1/2	Y
0647	POW	3/4 x 12	11	1/2	Y
0650	POW	7/8 x 12	10	1/2	A
0654	POW	1 x 12	10	1/2	Y

Spline, SDS and SDS-max Component Systems

Thin Wall, Carbide-Tipped Core Bits



Code	Diameter	Core Body w/Guide Plate & Centering Pin	SPLINE Adapter Shanks 12" Long	SDS Adapter Shanks 8" Long	SDS Adapter Shanks 12" Long	SDS-max Adapter Shanks 12" Long	Extension 7 1/2" Long	Replacement Guide Plate	Replacement Centering Pin
MIL	1"	48-20-5005 / A*	—	48-03-3545 / A*	48-03-3551 / Y*	—	48-95-6070 / A*	—	—
MIL	1 1/8"	48-20-5010 / A*	—	48-03-3545 / A*	48-03-3551 / Y*	—	48-95-6070 / A*	—	—
MIL	1 1/4"	48-20-5015 / Y*	—	48-03-3545 / A*	48-03-3551 / Y*	—	48-95-6070 / A*	48-20-6151 / A*	48-20-6150 / A*
MIL	1 3/8"	48-20-5020 / A*	—	48-03-3545 / A*	48-03-3551 / Y*	—	48-95-6070 / A*	48-20-6152 / A*	48-20-6150 / A*
MIL	1 1/2"	48-20-5025 / Y*	—	48-03-3545 / A*	48-03-3551 / Y*	—	48-95-6070 / A*	48-20-6153 / A*	48-20-6150 / A*
MIL	1 3/4"	48-20-5030 / A*	—	48-03-3555 / A*	48-03-3561 / Y*	—	48-95-6075 / A*	48-20-6156 / A*	48-20-6155 / Y*
MIL	2"	48-20-5035 / Y*	—	48-03-3555 / A*	48-03-3561 / Y*	—	48-95-6075 / A*	48-20-6157 / A*	48-20-6155 / Y*
MIL	2 1/2"	48-20-5040 / Y*	—	48-03-3555 / A*	48-03-3561 / Y*	—	48-95-6075 / A*	48-20-6158 / A*	48-20-6155 / Y*
MIL	3"	48-20-5045 / Y*	—	48-03-3555 / A*	48-03-3561 / Y*	—	48-95-6075 / A*	48-20-6159 / A*	48-20-6155 / Y*
MIL	3 1/2"	48-20-5050 / A*	—	48-03-3555 / A*	48-03-3561 Y*	—	48-95-6075 / A*	48-20-6160 / A*	48-20-6155 / Y*
MIL	4"	48-20-5055 / Y*	—	48-03-3555 / A*	48-03-3561 / Y*	—	48-95-6075 / A*	48-20-6161 / A*	48-20-6155 / Y*
MIL	5"***	48-20-5060 / Y*	48-03-3540 / Y*†	—	—	48-03-3574 / A*	48-95-6075 / A*	48-20-6162 / A*	48-20-6155 / Y*
MIL	6"***	48-20-5065 / A*	48-03-3540 / Y*	—	—	48-03-3574 / A*	48-95-6075 / A*	48-20-6163 / A*	48-20-6155 / Y*

†Not recommended for SDS hammers

*Y = stock item; A = readily available by order

Drill Bits - Concrete Drilling



Carbide Rock Bit

H-Thread Shallow Bit - One Use

- 3/16" carbide depth; nonresharpenable



Item #	Code	Diameter (Inches)	Stock*
HSC138	VUL	1 3/8	Y
HSC112	VUL	1 1/2	Y
HSC158	VUL	1 5/8	Y
HSC134	VUL	1 3/4	Y
HSC178	VUL	1 7/8	A
HSC2	VUL	2	Y



H-Thread Multi-Use Bit

- 3/16" carbide depth

Item #	Code	Diameter (Inches)	Stock*
HC212	VUL	2 1/2	Y
HC214	VUL	2 1/4	Y
HC3	VUL	3	Y

H-Thread Drill Rod



Code	Length (Feet)	7/8" x 3/4"			7/8" x 4/4"			1" x 4/4"		
		Item #	Weight (lb.)	Stock*	Item #	Weight (lb.)	Stock*	Item #	Weight (lb.)	Stock*
VUL	1	520-1	2 3/4	A	521-1	2 3/4	A	522-1	4	A
VUL	1 1/2	520-1.5	3 3/4	A	521-1.5	3 3/4	A	522-1.5	5 1/4	Y
VUL	2	520-2	5	A	521-2	5	A	522-2	7	Y
VUL	2 1/2	520-2.5	6	A	521-2.5	6	A	522-2.5	8 1/2	A
VUL	3	520-3	7	A	521-3	7	A	522-3	10	Y
VUL	4	520-4	9	A	521-4	9	A	522-4	12 1/2	Y
VUL	5	520-5	11	A	521-5	11	A	522-5	15	A
VUL	6	520-6	13	A	521-6	13	A	522-6	17	Y
VUL	7	520-7	15	A	521-7	15	A	522-7	20	A
VUL	8	520-8	17	A	521-8	17	A	522-8	22	A
VUL	9	520-9	19	A	521-9	19	A	522-9	25	A
VUL	10	520-10	22	A	521-10	22	A	522-10	28	A
VUL	12	520-12	26	A	521-12	26	A	522-12	33	A

Pavement Breaker Tools

Chipping Hammer Tool

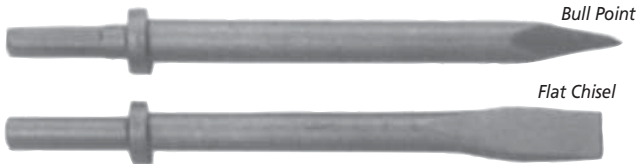

Code	Blade Type	FO 9"	FO 12"	GO 9"	GO 12"	F 9"	F 12"	G 9"	G 12"
VUL	Chisel Blank	F0100	F0101	G0100	G0101	F100	F101	G100	G101
VUL	Bull Point	F0120	F0121	G0120	G0121	F12	F121	G120	G121**
VUL	Flat Chisel	F0180	F0181	G0180	G0181**	F180	F181	G180**	G181**
VUL	Scaling Chisel - 1 1/2" blade	F02805	F02815	G02805	G02815	F2805	F2815	G2805	G2815
VUL	Scaling Chisel - 2" blade	F02802	F02812	G02802	G02812	F2802	F2812	G2802	G2812**
VUL	Bushing Tool - 1 3/4" square; 16 teeth	F0240		G0240		F240		G240	
VUL	Bushing Tool - head only; 16 teeth	248		248		248		248	
VUL	Bushing Tool - shank only	F0250		G0250		F250		G250	

FO = Round Shank/
Oval Collar
GO = Hex Shank/
Oval Collar
F = Round Shank/
Round Collar
G = Hex Shank/
Round Collar

****Stock Item**

Asphalt Cutter

- Blade width: 5"
- Blade length: 6"
- Length U.C.: 11"



Item #	Code	Shank Size Hexagon	Weight (lb.)	Stock*
942	VUL	7/8" x 3/4"	7	A
943	VUL	1" x 4/4"	7 1/4	A
1045	VUL	1 1/8" x 6"	8 1/2	Y
1046	VUL	1 1/4" x 6"	9 1/4	A

Bushing Tool

- No. of teeth: 16
- Length U.C.: 9"



Item #	Code	Shank Size Hexagon	Weight (lb.)	Stock*
846	VUL	7/8" x 3/4"	6	A
847	VUL	1" x 4/4"	6 1/2	A
848	VUL	1 1/8" x 6"	8	A
849	VUL	1 1/4" x 6"	8 1/2	A



Pavement Breaker Tools

Narrow Chisel - Standard



Item #	Code	Shank Size Hexagon	Length U.C.	Weight (lb.)	Stock*
923	VUL	7/8" x 3/4"	14"	3 1/4	A
924	VUL		18"	4	A
924-2	VUL		24"	5	A
924-3	VUL		36"	7	A
925-VUL	VUL	1" x 4 1/4"	14"	4 1/2	Y
926	VUL		18"	5 1/2	A
926-2	VUL		24"	6 3/4	A
926-3	VUL		36"	10	A
1030-VUL	VUL	1 1/2" x 6"	14"	6	Y
1031	VUL		18"	7 1/2	A
1031-2	VUL		24"	9	A
1031-3	VUL		36"	13	A
1034	VUL	1 1/4" x 6"	14"	7 1/2	A
1035	VUL		18"	9	A
1035-2	VUL		24"	11 1/2	A
1035-3	VUL		36"	16	A

3" Chisel - Standard



Item #	Code	Shank Size Hexagon	Length U.C.	Weight (lb.)	Stock*
934	VUL	7/8" x 3/4"	14"	3 1/2	A
935	VUL		18"	4 1/4	A
935-2	VUL		24"	5 1/2	A
935-3	VUL		36"	8	A
936	VUL	1" x 4 1/4"	14"	4 3/4	Y
937	VUL		18"	5 3/4	Y
937-2	VUL		24"	7	A
937-3	VUL		36"	10	A
1040-VUL	VUL	1 1/2" x 6"	14"	6 3/4	Y
1041	VUL		18"	7 3/4	A
1041-2	VUL		24"	9	A
1041-3	VUL		36"	13	A
1042	VUL	1 1/4" x 6"	14"	8 1/4	A
1043	VUL		18"	9 3/4	A
1043-2	VUL		24"	11	A
1043-3	VUL		36"	16	A

Moil Point - Standard



Item #	Code	Shank Size Hexagon	Length U.C.	Weight (lb.)	Stock*
1011	VUL	7/8" x 3/4"	14"	3 1/4	A
1012	VUL		18"	4	A
1012-2	VUL		24"	5	A
1012-3	VUL		36"	7	A
1013	VUL	1" x 4 1/4"	14"	4 1/2	Y
1014	VUL		18"	5 1/2	A
1014-2	VUL		24"	6 3/4	A
1014-3	VUL		36"	10	A
1019	VUL	1 1/2" x 6"	14"	6	Y
1020	VUL		18"	7 1/2	A
1020-2	VUL		24"	9	A
1020-3	VUL		36"	13	A
1023	VUL	1 1/4" x 6"	14"	7 1/2	A
1024	VUL		18"	9	A
1024-2	VUL		24"	11 1/2	A
1024-3	VUL		36"	16	A

Chipping Hammer Steel



SDS-plus® Hammer Steel

Item #	Code	Description	Size	Stock*
HS1415	BOS	Point	10"	Y
HS1420	BOS	Chisel	3/4" x 10"	Y
HS1425	BOS	Wide Chisel	1 1/2" x 10"	Y
HS1427	BOS	Wide Chisel	2 1/2" x 10"	Y
HS1470	BOS	Viper Flat Chisel	3/4" x 10"	Y
HS1472	BOS	Point	10"	Y
HS1475	BOS	Gouging Chisel	10"	Y
HS1480	BOS	Carbide Tipped Point	8"	Y
HS1490	BOS	Stubby Point	5 3/4"	Y
HS1495	BOS	Stubby Flat Chisel	3/4" x 5 3/4"	Y

*Y = stock item; A = readily available by order

Chipping Hammer Steel



SDS-max® Hammer Steel

Item #	Code	Description	Size	Stock*
HS1906	BOS	Asphalt Cutter	5" x 15"	A
HS1913	BOS	Bull Point	12"	Y
HS1914	BOS	Bull Point	18"	A
HS1909	BOS	Bushing Tool One Piece	16-tooth head; 1 3/4" square x 9 1/4"	Y
HS1922	BOS	Clay Spade	4 1/2" x 17"	Y
HS1903	BOS	Flat Chisel	1" x 16"	Y
HS1911	BOS	Flat Chisel	1" x 12"	Y
HS1912	BOS	Flat Chisel	1" x 18"	A
HS1918	BOS	Floor Scraper	6" x 25"	Y
HS1929	BOS	Gouge	1" x 12"	Y
HS1924	BOS	Ground Rod Driver	5/8" x 3/4" rods; inside dia. .906", inside depth 2 3/4" x 20"	Y
HS1926	BOS	Round Spade	4 1/2" x 16"	A
HS1916	BOS	Scaling Chisel	1 1/2" x 12"	A
HS1917	BOS	Scaling Chisel	2" x 12"	Y
HS1910	BOS	Scaling Chisel	3" x 12"	Y
HS1915	BOS	Scraping Chisel	2" x 12"	Y
HS1920	BOS	Seam Tool	1 1/8" x 15"	A
HS1921	BOS	Slotting Tool	1 1/8" x 15"	A
HS1934	BOS	Star Point Chisel Twist	16"	Y
HS1828	BOS	Tamper Plate	5" x 5"	A
HS1927	BOS	Tamper Plate Shank	12"	A
HS1928	BOS	Winged Channel Chisel	1" x 15"	A



3/4" Hex Hammer Steel



Item #	Code	Description	Size	Stock*
HS1506	BOS	Asphalt Cutter	5" x 15"	A
HS1515	BOS	Bull Point	12"	Y
HS1516	BOS	Bull Point	18"	A
HS1521	BOS	Bushing Head	16-tooth head; 1 3/4" square	A
HS1508	BOS	Bushing Head Shank	12"	A
HS1520	BOS	Bushing Tool One Piece	16-tooth head; 1 3/4" square x 9 1/4"	Y
HS1504	BOS	Clay Spade	4 1/2" x 17"	A
HS1517	BOS	Flat Chisel	1" x 12"	Y
HS1518	BOS	Flat Chisel	1" x 18"	Y
HS1524	BOS	Ground Rod Driver	5/8" x 3/4" rods; inside dia. .906", inside depth 2 3/4" x 20"	Y
HS1526	BOS	Pointed Spade	4 1/2" x 16"	A
HS1503	BOS	Scaling Chisel	3" x 12"	Y
HS1502	BOS	Scraping Chisel	2" x 12"	Y
HS1828	BOS	Tamper Plate	5" x 5"	A
HS1527	BOS	Tamper Plate Shank	12"	A

Round Hex Hammer Steel

3/4" Hex with 21/32" Round



Item #	Code	Description	Size	Stock*
HS1813	BOS	Bull Point	12"	Y
HS1814	BOS	Bull Point	18"	Y
HS1521	BOS	Bushing Head	6-tooth head; 1" x 1 3/4" square	A
HS1818	BOS	Bushing Head Shank	12"	A
HS1809	BOS	Bushing Tool One Piece	16-tooth head; 1 3/4" square x 9 1/4" length	Y
HS1822	BOS	Clay Spade	4 1/2" x 17"	A
HS1811	BOS	Flat Chisel	1" x 12"	Y
HS1812	BOS	Flat Chisel	1" x 18"	Y
HS1824	BOS	Ground Rod Driver	5/8" & 3/4" rods; inside dia. .906", inside depth 2 3/4" x 20"	Y
HS1826	BOS	Pointed Spade	4 1/2" x 16"	A
HS1816	BOS	Scaling Chisel	1 1/2" x 12"	A
HS1817	BOS	Scaling Chisel	2" x 12"	Y
HS1810	BOS	Scaling Chisel	3" x 12"	Y
HS1815	BOS	Scraping Chisel	2" x 12"	Y
HS1820	BOS	Seam Tool	1 1/8" x 15"	A
HS1821	BOS	Slotting Tool	1 1/8" x 15"	A
HS1828	BOS	Tamper Plate	5" x 5"	A
HS1827	BOS	Tamper Plate Shank	12"	A

Rotozip Cutting Accessories

Zip®Bits



Item #	Code	Description	Application	Qty./Pkg.	Stock*
FBR1	ROT	Fiberock® - 1/4" shank, carbide	Fiberock panels	1	Y
SC4-ROT	ROT	Sabrecut™ - 1/8" shank	Variety of materials from wood to fiberglass	5	Y
TC1	ROT	Tilecut™ - 1/8" shank, carbide	Ceramic wall tile, cement board (only soft tile w/glazing), stucco, plaster	1	Y
WD1	ROT	Window/Door - 1/4" shank	Cutting window & door openings in drywall	1	Y
ZB8	ROT	Standard Point - 1/8" shank	Basic drywall cut-outs	8	Y
ZB50	ROT	Standard Point - 1/8" shank	Basic drywall cut-outs	50	Y

XWHEELS™



Item #	Code	Description	Application	Qty./Pkg.	Stock*
XWMET1	ROT	Metal, applications up to 3/4"	Metal door jambs, rebar, Unistrut®, metal stud, threaded rod, HVAC, copper	1	Y
XWTILE1	ROT	Tile, applications up to 3/4"	Ceramic floor tile, porcelain, slate, marble, granite	1	Y
XWWD1	ROT	Wood, applications up to 3/4"	Variety of wood, including laminate flooring, OSB, oak, pine, plywood	1	Y

Zip®WHEELS



Item #	Code	Description	Application	Qty./Pkg.	Stock*
RZDIA1	ROT	Dry Diamond, applications up to 9/16"	Floor tile, concrete, stone, ceramics	1	Y
RZMET2	ROT	Metal, applications up to 9/16"	Ferrous/nonferrous metals, such as steel, iron, pipe, sheet metal, aluminum	2	Y



XBITS™



Item #	Code	Description	Application	Qty./Pkg.	Stock*
XBDC1	ROT	Duracut™ - 1/4" shank	Cement board, stucco, plaster	1	Y
XBDW2	ROT	Drywall - 5/32" shank	Faster, controlled cut-outs from outlets to window/door openings	2	Y
XBFT1	ROT	Tile - 1/8" shank, diamond grit	Intricate cuts in porcelain, slate, granite, slate, ceramic tile up to 1/2" thick	1	Y
XBLF1	ROT	Laminate Floor - 5/32" shank	Variety of laminate flooring materials	1	Y
XBMC1	ROT	Metal - 5/32" shank	Aluminum and steel up to 18-gauge	1	Y
XBMP2	ROT	Multipurpose - 5/32" shank	Variety of materials from wood to fiberglass	2	Y
XBMPDM2	ROT	Dust Management - 5/32" shank	Up-bit flute design for optimized dust collection in a variety of materials from wood to fiberglass	2	Y
XBTC1	ROT	Tilecut™ - 5/32" shank	Ceramic wall tile, cement board (only soft tile w/glazing), stucco, plaster	1	Y
XBUL1	ROT	Underlayment - 5/32" shank	Fiber backerboard and other underlayment materials	1	Y

XCORES™



Item #	Code	Description	Application	Qty./Pkg.	Stock*
XCT750	ROT	3/4" High Speed, Diamond Hole Saw Bit	Cuts all of the hardest materials, such as porcelain, granite, marble, slate, ceramic and stone up to 3 cm thick	1	Y
XCT1000	ROT	1" High Speed, Diamond Hole Saw Bit		1	Y
XCT1375	ROT	1 3/8" High Speed, Diamond Hole Saw Bit		1	Y

Oscillating Multi-Tool Accessories



Cutting Blade

Multi-tool accessory for cutting wood, hardwood, sheet metal, tile, stone, fiberglass or nail-embedded wood.

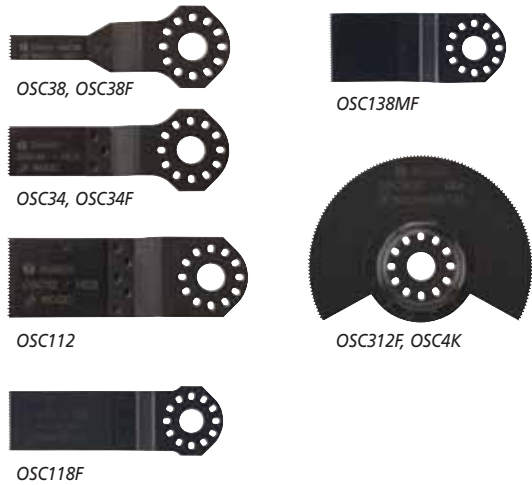

Item #	Code	Description	Size	Application	Stock*
OSC38	BOS	HCS Plunge Cut Blade	3/8"	Cutting wood floors, dowels or trim work	Y
OSC34	BOS	HCS Plunge Cut Blade	3/4"	Cutting wood floors, dowels or trim work	Y
OSC112	BOS	HCS Plunge Cut Blade	1 1/4"	Cutting door jambs and trim work	Y
OSC38F	BOS	BIM Plunge Cut Blade	3/8"	Cutting nails in trim work	Y
OSC34F	BOS	BIM Plunge Cut Blade	3/4"	Cutting nails in trim work	Y
OSC118F	BOS	BIM Plunge Cut Blade	1 1/8"	Cutting wood floors or metal (nails and staples)	Y
OSC138MF	BOS	BIM Plunge Cut Blade	1 1/4"	Cutting thin gauge metal (sheet metal and metal studs)	Y
OSC312F	BOS	BIM Segmented Saw Blade	3 1/2"	Trimming door jambs with nails	Y
OSC4K	BOS	BIM Segmented Saw Blade	4"	Making wide cuts in door jambs and cutting nails in trim wok	Y

Grinding Blade

Multi-tool accessory for grout removal between closely set tiles and for cutting abrasive materials.



Item #	Code	Description	Size/ Kerf	Application	Stock*
OSC312RF	BOS	Carbide Grit Blade	3 1/2" / 1/16"	Removing grout between set tiles	Y
OSC312DG	BOS	Diamond Grit	3 1/2" / 1/8"	Cutting abrasive materials or tile	Y

Scraping Blade

Multi-tool accessory for removing paint, caulk, adhesive and window putty from many surfaces, including tubs, showers, faucets and sensitive glass. Blade can also be used to remove flooring materials like linoleum and carpet.



Item #	Code	Description	Size	Application	Stock*
OSC214C	BOS	HCS Caulk Knife	2"	Removing adhesive/caulk from tubs, showers, sinks & faucets	Y
OSC2FSC	BOS	HCS Flexible Scraper	2"	Removing linoleum, carpet, window putty, paint, hard caulk	Y
OSC2RSC	BOS	HCS Rigid Scraper	2"	Removing linoleum, carpet, window putty, paint, hard caulk	Y

BOSCH Multi-X™ cordless and corded tool kits can be found on page 18 and page 25.



*Y = stock item; A = readily available by order

Abrasives - Grinding

Type 27 Depressed Center Wheel - 1/4"

A24N—Metal: Fast Grinding

- Aluminum oxide grain
- Soft bond for fast stock removal
- Ferrous metals (iron, steel, welds, etc.)
- Low grade stainless steel



A24R—Metal: Long Life

- Aluminum oxide grain
- For general purpose grinding
- Longer life for fewer wheel changes
- Ferrous metals (iron, steel, welds, etc.)

Size (inches)			Max. RPM	Item #				Code
Dia.	Width	Bore		A24N Grade	Stock*	A24R Grade	Stock*	
3	3/16	3/8	18,000	20001	A	—	A	SAI
3	1/4	3/8	18,000	20002	A	20005	A	SAI
4	3/16	3/8	18,000	20010	A	—	A	SAI
4	1/4	3/8	18,000	20012	A	20019	A	SAI
4	1/4	5/8	18,000	20015	Y	20013	A	SAI
4 1/2	3/16	7/8	18,000	20050	A	—	A	SAI
4 1/2	3/16	5/8-11	18,000	20150	A	—	A	SAI
4 1/2	1/4	7/8	18,000	20060	A	20063	Y	SAI
4 1/2	1/4	5/8-11	18,000	20160	Y	20163	A	SAI
5	1/4	7/8	18,000	20070	Y	20073	A	SAI
5	1/4	5/8-11	18,000	20170	A	20173	A	SAI
6	1/4	7/8	18,000	20078	A	20079	A	SAI
6	1/4	5/8-11	18,000	20178	A	20076	A	SAI
7	1/4	7/8	18,000	20081	A	20080	A	SAI
7	1/4	5/8-11	18,000	20085	A	20086	Y	SAI
9	1/4	7/8	18,000	20091	A	20090	A	SAI
9	1/4	5/8-11	18,000	20095	A	20096	Y	SAI

Bench Grinding Wheel

A—Metal

- Aluminum oxide grain
- For sharpening tools and light stock removal
- Ferrous metals (iron, steel, carbon steel, forgings, etc.)



Size (inches)			Max. RPM	Item #				Code
Dia.	Width	Bore		A36 Grade	Stock*	A60 Grade	Stock*	
6	3/4	1	4,138	28000	Y	28001	Y	SAI
8	1	1	3,600	—	—	28023	Y	SAI

*Y = stock item; A = readily available by order



C24N—Concrete

- Silicon carbide grain
- Soft bond for fast stock removal
- Masonry, concrete, stone
- Cast iron and other ferrous metals

Size (inches)			Max. RPM	Item #	Code	Stock*
Dia.	Width	Bore				
4	1/4	5/8	13,500	20017	SAI	A
4 1/2	1/4	7/8	13,300	20061	SAI	Y
4 1/2	1/4	5/8-11	13,300	20161	SAI	A
5	1/4	7/8	12,200	20071	SAI	Y
5	1/4	5/8-11	12,200	20171	SAI	A
7	1/4	7/8	8,500	20082	SAI	A
7	1/4	5/8-11	8,500	20087	SAI	Y
9	1/4	7/8	6,600	20092	SAI	A
9	1/4	5/8-11	6,600	20097	SAI	A

Saitech Ultimate Performance—Stainless Steel

- High performance, ceramic aluminum oxide grain
- Very uniform, high density grain structure is extremely durable and self-sharpening for long life and cooler cut
- Combines fast stock removal with long life
- Stainless steel and other high tensile alloys
- Ferrous metals (iron, steel, welds, etc.)



Size (inches)			Max. RPM	Item #	Code	Stock*
Dia.	Width	Bore				
4 1/2	1/4	7/8	13,300	20064	SAI	Y

Hand & Floor Rub

Vitrified rubs, although somewhat brittle, are not affected by water, oil, most acids, or temperature changes. Used primarily for precision and fixed-feed applications, they are particularly well suited for bench grinders and offhand tool room applications.

- Removes form marks
- Concrete
- Available with a handle for extra comfort and working overhead or scored to break into two 4 x 2 x 2 floor rubs



Size (inches)			Description	Grade	Item #	Code	Stock*
Length	Width	Height					
6	3	1	Handle	C24R	25040	SAI	Y
8	2	2	Scored	C10R	25060	SAI	Y

Abrasives - Grinding

Type 11 Cup Stones



C16—Concrete

- Silicon carbide grain
- Coarse grit for tough grinding applications
- Excellent for cleaning castings, mold marks, and removing flashing
- Masonry, concrete, stone
- Available with optional metal backing

CA16—Combination

- Combination of aluminum oxide and silicon carbide grains
- Excellent for cleaning castings, mold marks, and removing flashing
- Use on combination of ferrous metals and/or concrete materials
- Available with optional metal backing

Size (inches)				Grade	Max. RPM	Item #	Stock*
Bottom Dia.	Top Dia.	Width	Bore				
4	3	2	5/8-11	C16	9,050	26001	Y
4	3	2	5/8-11	CA16	9,050	26002	A
5	4	2	5/8-11	C16	7,250	26011	Y
5	4	2	5/8-11	CA16	7,250	26012	A
6	4 3/4	2	5/8-11	C16	6,050	26021	A
6	4 3/4	2	5/8-11	CA16	6,050	26022	A



Z16—Zirconium

- Special Zirconium grain formulation
- Coarse grit and hard bond for the toughest grinding applications
- Outlasts standard Aluminum Oxide Cup wheels 2:1
- Ferrous metals and stainless steel
- Available with optional metal backing



A16—General Purpose

- Aluminum oxide grain
- Coarse grit wheel for tough grinding applications
- Excellent for cleaning castings, mold marks, removing flashing
- Ferrous metals
- Available with optional metal backing

Size (inches)				Grade	Max. RPM	Item #	Stock*
Bottom Dia.	Top Dia.	Width	Bore				
4	3	2	5/8-11	A16	9,050	26000	A
5	4	2	5/8-11	A16	7,250	26010	A
5	4	2	5/8-11	Z16	7,250	26050	A
6	4 3/4	2	5/8-11	A16	6,050	26020	Y
6	4 3/4	2	5/8-11	Z16	6,050	26060	A

Abrasives - Cutting

Type 1 Thin High Speed Cut-off - .045"

A60S—Metal

- Use with reusable 5/8-11 adaptor to fit angle grinders
- Extremely fast cutting with long life
- Ferrous and/or nonferrous metals (iron, steel, welds, etc.)



Size (inches)			Max. RPM	Item #	Code	Stock*
Dia.	Width	Bore				
7	.045	5/8	8,500	23107	SAI	Y

Type 1 Thin High Speed Cut-off Wheel

A36T—Metal: Fast Cutting

- Aluminum oxide grain
- Hard bond for aggressive cutting on rough applications
- Ferrous metals (iron, steel, welds, etc.) and stainless steel



Size (inches)			Max. RPM	Item #	Code	Stock*
Dia.	Width	Bore				
3	1/16	3/8	25,000	23040	SAI	Y
4	1/16	5/8	19,000	23061	SAI	Y

YOUR SATISFACTION
IS GUARANTEED!

*Y = stock item; A = readily available by order

Abrasives - Cutting

Type 27 Depressed Center Wheel - 1/8"

C24R—Concrete

- Silicon carbide grain
- General purpose cutting, hard bond for long life
- Masonry, concrete, stone
- Cast iron and other ferrous metals



Size (inches)			Max. RPM	Item #	Code	Stock*
Dia.	Width	Bore				
4	1/8	5/8	13,500	22017	SAI	A
4 1/2	3/32	7/8	13,300	22025	SAI	Y
4 1/2	3/32	5/8-11	13,300	22125	SAI	A
5	1/8	7/8	12,200	22041	SAI	Y
5	1/8	5/8-11	12,200	22141	SAI	A
7	1/8	7/8	8,500	22050	SAI	A
7	1/8	5/8-11	8,500	22051	SAI	A
9	1/8	7/8	6,600	22060	SAI	A
9	1/8	5/8-11	6,600	22061	SAI	A

Type 27 Depressed Center Wheel - .090"

A60S—Metal

- Special aluminum oxide grain
- Hard bond for extremely long life
- Ferrous and/or nonferrous metals (iron, steel, welds, etc.)



Size (inches)			Max. RPM	Item #	Code	Stock*
Dia.	Width	Bore				
4 1/2	.090	7/8	13,300	20903	SAI	Y

Type 27 Specialty Cutting Wheel - 3/32"

A24R—Metal

- Aluminum oxide grain
- For general purpose use
- Combines fast cutting and long life
- Ferrous metals (iron, steel, welds, etc.)



Size (inches)			Max. RPM	Item #	Code	Stock*
Dia.	Width	Bore				
4 1/2	3/32	7/8	13,300	22020	SAI	Y



SAIT

Type 27 Depressed Center Wheel - .045"

A60S—Metal

- Special aluminum oxide grain
- Hard bond for extremely long life
- Fast, burr-free cutting
- Ferrous and/or nonferrous metals (iron, steel, welds, etc.)



Size (inches)			Max. RPM	Item #	Code	Stock*
Dia.	Width	Bore				
4 1/2	.045	7/8	13,300	22021	SAI	Y

Type 27 High Performance Wheel - .045"

Saitech .045—Stainless Steel

- High performance, ceramic aluminum oxide grain
- Very uniform, high density grain structure is extremely durable and self-sharpening for long life and cooler cut
- Fast cutting with long life
- Stainless steel, high tensile alloys
- Ferrous metals (iron, steel, welds, etc.)



Z-Tech—Metal

- Special zirconium grain
- Thin .045 width
- Hard bond for extremely long life
- Fast, burr-free cutting
- Ferrous and/or nonferrous metals (iron, steel, welds, etc.)
- Stainless steel, high tensile alloys



Size (inches)			Max. RPM	Item #			Code	
Dia.	Width	Bore		Saitech Grade	Stock*	Z-Tech Grade		Stock*
4 1/2	.045	7/8	13,300	22072	Y	23334	Y	SAI



Rapido™ Metal Cutting Wheel - .040"

- Aluminum oxide special grain
- Resin bond and fiberglass reinforcing



Item #	Code	Grit	Diameter (Inches)	Arbor (Inches)	Maximum RPM	Stock*
TCW1S450	BOS	60	4 1/2 x .040	7/8	13,280	Y
TCW1S6XT	BOS	60	6 x .040	7/8	10,200	Y

Abrasives - Cutting

Type 1 Portable Saw Cut-off Wheel

A24R—Metal: General Purpose

- Aluminum oxide grain
- Provides consistent performance with long life
- Ferrous metals (steel, angle iron, rebar)



A30S—Long Life

- Special aluminum oxide grain formula
- Fast, non-binding cutting
- Ferrous metals, stainless steel, high tensile alloys

Size (inches)			Max. RPM	Item #				Code
Dia.	Width	Bore		A24R Grade	Stock*	A30S Grade	Stock*	
7	3/32	5/8	8,500	23234	Y	—	—	SAI
8	3/32	5/8	7,600	23258	A	—	—	SAI
12	1/8	1	6,300	23410	Y	—	—	SAI
12	1/8	1	6,300	—	—	23430	A	SAI
12	1/8	7/8	6,300	23400	A	—	A	SAI
12	1/8	7/8	6,300	—	—	23431	A	SAI
12	1/8	20 mm	6,300	23420	Y	—	A	SAI
12	1/8	20 mm	6,300	—	—	23432	A	SAI
14	1/8	1	5,400	23450	Y	—	—	SAI
14	1/8	1	5,400	—	—	23440	A	SAI
14	1/8	20 mm	5,460	2414-SAI	Y	—	—	SAI
14	1/8	20 mm	5,460	—	—	23441	A	SAI
16	1/8	1	4,800	23459	Y	—	—	SAI
16	1/8	20 mm	4,800	23470	A	—	—	SAI

C24R—Concrete

- Silicon carbide grain
- Long life
- Stone, brick, soft aggregate, masonry, concrete



Size (inches)			Max. RPM	Item #	Code	Stock*
Dia.	Width	Bore				
7	3/32	5/8	8,500	23235	SAI	Y
8	3/32	5/8	7,600	23259	SAI	A

Type 1 Street Saw Wheel

C16—Concrete

- Silicon carbide grain
- Fast, free cutting
- Green concrete, asphalt

Size (inches)			Max. RPM	Item #	Code	Stock*
Dia.	Width	Bore				
14	3/16	1	4,400	24061	SAI	Y

Ductile™—Combination Metal/Concrete

- Combination aluminum oxide and silicon carbide formulation
- Ductile pipe (very hard steel casing enclosing a cement lining), water mains, etc.
- Combination metal/concrete, cast iron, hard metals, concrete coated steel, etc.



Size (inches)			Max. RPM	Item #	Code	Stock*
Dia.**	Width	Bore				
12	1/8	1	6,300	23415	SAI	Y
12	1/8	20 mm	6,300	23425	SAI	Y
14	1/8	1	5,400	23453	SAI	Y
14	1/8	20 mm	5,460	23458	SAI	Y
16	1/8	1	4,800	23480	SAI	A
16	1/8	20 mm	4,800	23478	SAI	A

**All 14" and 16" portable wheels now formulated for high powered saws. 14" (20 mm) with higher RPM rating for STIHL saws.

Big M.A.C.—Masonry Asphalt Concrete:

- Special silicon carbide grain
- Superior cutting action
- 40% longer life than general purpose concrete wheels
- Masonry, asphalt, concrete



Size (inches)			Max. RPM	Item #	Code	Stock*
Dia.**	Width	Bore				
12	1/8	1	6,300	23460	SAI	Y
12	1/8	20 mm	6,300	23462	SAI	Y
14	1/8	1	5,400	23463	SAI	Y
14	1/8	20 mm	5,460	23464	SAI	Y

** All 14" and 16" portable wheels now formulated for high power saws. 14" (20 mm) with higher RPM rating for STIHL saws.



*Y = stock item; A = readily available by order

Abrasives - Cutting

Type 1 Chop Saw Wheel

EZ-Chop Attacker®

- Aluminum oxide grain
- General purpose economy cutting
- Fast cutting on thin metals
- Metal studding, thin rebar, light gauge and medium metals

Stud King®

- Aluminum oxide grain
- General purpose cool cutting
- Burr-free finish
- Metal studding, thin rebar, light gauge metals

Iron Worker™

- Aluminum oxide grain
- Fast cutting
- Angle iron, channel iron, heavy rebar and other ferrous metals

Steel Worker®

- Formulated with 3M Cubitron™ grain
- Extremely fast, burr-free finish
- Stainless steel, high tensile alloys and ferrous metals (iron, steel, welds, etc.)



Size (inches)			Max. RPM	Item #								Code
Dia.	Width	Bore		EZ-Chop Attacker	Stock*	Stud King	Stock*	Iron Worker	Stock*	Steel Worker	Stock*	
14	3/32	1	4,400	24500	Y	24050	Y	24051	Y	24053	Y	SAI
12	3/32	1	5,100	—	Y	24030	Y	24031	A	24033	Y	SAI
10	3/32	5/8	6,100	—	Y	24035	Y	—	Y	—	Y	SAI

Abrasives - Cutting/Grinding

Type 27 Specialty Pipeline Wheel - 1/8"

A24R Pipeline—Metal: Long Life

- Aluminum oxide grain
- For the pipeline industry
- Designed and manufactured to perform both cutting and light grinding
- Ferrous metals (iron, steel, welds, etc.)

Size (inches)			Max. RPM	Item #	Code	Stock*
Dia.	Width	Bore				
5	1/8	7/8	12,200	22040	SAI	Y
9	1/8	5/8-11	6,600	22062	SAI	Y



Abrasives - Sandblasting

Iron Slag

Iron slag abrasive material is used to remove paint and rust from steel and concrete.

Available in two grades:

- Medium - use for general purpose repair and maintenance blasting
- Fine - use for new construction, light paint and rust removal, and for special maintenance applications requiring reduced profiles

Item #	Code	Description	Stock*
BB60-F	ABR	Fine Grade - 60 lb. bag	Y
BB60-M	ABR	Medium Grade - 60 lb. bag	Y

*Y = stock item; A = readily available by order

Abrasives - Sanding



Flap Disc

Saitlam: Type 27 Flat Shape

- Material: 2A – aluminum oxide
Z – zirconium
- Nylon 6/6 backing—a nonscratching, high strength backing resistant to temperature extremes, common chemicals and solvents
- Provides an even “finish ready” surface
- Excellent for miter joints, corners and edges

Material: 2A – Aluminum Oxide

Size (in.)		Grit	Max. RPM	Item #	Code	Stock*
Dia.	Arbor					
4	5/8	40	13,000	73240	SAI	A
4	5/8	60	13,000	73260	SAI	A
4	5/8	80	13,000	73280	SAI	A
4	5/8	120	13,000	73220	SAI	A
4 1/2	7/8	40	11,000	73440	SAI	A
4 1/2	7/8	60	11,000	73460	SAI	Y
4 1/2	7/8	80	11,000	73480	SAI	Y
4 1/2	7/8	120	11,000	73420	SAI	A
6 1/2	7/8	36	8,600	73636	SAI	A
6 1/2	7/8	50	8,600	73650	SAI	A
6 1/2	7/8	60	8,600	73660	SAI	A
6 1/2	7/8	80	8,600	73680	SAI	A
6 1/2	7/8	120	8,600	73620	SAI	A

Material: Z – Zirconium

Size (in.)		Grit	Max. RPM	Item #	Code	Stock*
Dia.	Arbor					
4	5/8	40	13,000	73140	SAI	A
4	5/8	50	13,000	73150	SAI	A
4	5/8	60	13,000	73160	SAI	A
4	5/8	80	13,000	73180	SAI	A
4 1/2	7/8	40	11,000	73540	SAI	Y
4 1/2	7/8	50	11,000	73550	SAI	A
4 1/2	7/8	60	11,000	73560	SAI	A
4 1/2	7/8	80	11,000	73580	SAI	A
6 1/2	7/8	36	8,600	73736	SAI	A
6 1/2	7/8	50	8,600	73750	SAI	A
6 1/2	7/8	60	8,600	73760	SAI	A
6 1/2	7/8	80	8,600	73780	SAI	A

Note: 4" and 4 1/2" Saitlam must be used with nut. 6 1/2" must be used with backing pad and nut



Fiber Disc 2A

- Aluminum oxide grain
- General purpose
- Closed coat structure for more material removal and better finishing
- Ferrous and/or nonferrous metals
- Wood, fiberglass, etc.

Size (in.)	Grit	Item #	Code	Stock*
4 1/2 x 7/8	24	50010-SAI	SAI	Y
	36	50011	SAI	Y
	50	50012	SAI	A
	60	50013-SAI	SAI	Y
	80	50014-SAI	SAI	Y
	100	50015-SAI	SAI	Y
7 x 7/8	120	50016-SAI	SAI	Y
	24	50031	SAI	Y
	36	50032	SAI	A
	50	50033	SAI	A
	60	50034-SAI	SAI	Y
	80	50035-SAI	SAI	Y
6 1/2 x 7/8	100	50036	SAI	Y
	120	50037	SAI	A



PSA Disc

Aluminum Oxide TA-X

- Aluminum oxide grain
- Strong X-weight Egyptian cotton cloth backing
- Closed coat structure
- Ferrous and/or nonferrous metals (iron, steel, aluminum, copper, etc.)
- Wood, fiberglass, plastic

Size (in.)	Grit	Item #	Code	Stock*
9	60	35140	SAI	Y
9	80	35141	SAI	Y
12	80	35169	SAI	A

Floor Sanding Disc

Grits 36-100

- Silicon carbide grain
- Closed coat for more material removal
- Excellent for general refinishing
- Wood

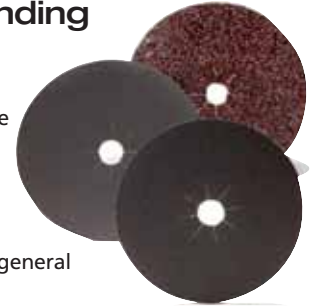

Size (in.)	Grit	Item #	Code	Stock*	
16 x 2	12	85122	SAI	A	
	16	85107	SAI	A	
	20	85108-SAI	SAI	Y	
	36	85109	SAI	A	
	40	85110	SAI	Y	
	60	85111	SAI	Y	
	80	85112	SAI	Y	
	100	85113	SAI	A	
	20 x 2	12	85140	SAI	A
		16	85141	SAI	A
20		85142	SAI	Y	
36		85143	SAI	A	
40		85144	SAI	A	
60		85145	SAI	A	
80		85146	SAI	A	
100		85147	SAI	A	

Have questions?

Please call our knowledgeable customer service.

*Y = stock item; A = readily available by order

Abrasives - Sanding

Sheets



Aluminum Oxide: DA-F

- Aluminum oxide grain
- Open coat structure prevents loading
- Water resistant
- Long life combined with excellent stock removal
- Excellent for woodworking applications
- Wood, plastic, fiberglass
- Ferrous and/or nonferrous materials (iron, steel, copper, etc.)

Size	Grit	Item #	Code	Stock*
9 x 11	36	84907	SAI	A
9 x 11	40	84908	SAI	A
9 x 11	50	84909	SAI	A
9 x 11	60	84910	SAI	Y
9 x 11	80	84911	SAI	Y
9 x 11	100	84912	SAI	Y
9 x 11	120	84913	SAI	Y
9 x 11	150	84914	SAI	Y
9 x 11	180	84915	SAI	Y
9 x 11	220	84916	SAI	Y
9 x 11	240	84917	SAI	A
9 x 11	320	84918	SAI	A

Check out
Porter Cable
belt sanders on
page 42.



Belts

Aluminum Oxide Cloth: 1A-X/2A-X Closed Coat

Semi-friable (1A-X)/heat-treatable (2A-X) aluminum oxide grain on an X-weight cotton backing. For general purpose grinding and finishing of ordinary and alloyed steels, ferrous and nonferrous metals, cast iron and wood.

Aluminum Oxide Cloth: AO-X Open Coat

Semi-friable aluminum oxide grain on an X-weight cotton backing. For general purpose, open coat grinding, polishing and finishing of materials that have a tendency to load. For use on nonferrous metals, aluminum and wood.



Size	Grit	Item #				Code
		AO-X	Stock*	1A-X/ 2A-X	Stock*	
3 x 21	24	58160	A	—	—	SAI
	36	58161	A	—	—	SAI
	40	58162	Y	—	—	SAI
	50	58163	A	57203	Y	SAI
	60	58164	A	57204	Y	SAI
	80	58165	A	57205	Y	SAI
	100	58166	Y	—	—	SAI
	120	58167	Y	57507	Y	SAI
	150	58168	A	—	—	SAI
	180	58169	A	57209	Y	SAI
3 x 24	24	58170	A	—	—	SAI
	36	58171	A	—	—	SAI
	40	58172	Y	—	—	SAI
	50	58173	A	—	—	SAI
	60	58174	Y	—	—	SAI
	80	58175	Y	—	—	SAI
	100	58176	Y	—	—	SAI
	120	58177	A	—	—	SAI
	150	58178	A	57508	A	SAI
	180	58179	A	—	—	SAI
4 x 21	24	58180	A	—	—	SAI
	36	58181	A	—	—	SAI
	40	58182	A	—	—	SAI
	50	58183	A	—	—	SAI
	60	58184	A	—	—	SAI
	80	58185	A	—	—	SAI
	100	58186	A	—	—	SAI
	120	58187	A	—	—	SAI
	150	58188	A	—	—	SAI
	180	58189	A	—	—	SAI

Size	Grit	Item #				Code
		AO-X	Stock*	1A-X/ 2A-X	Stock*	
4 x 24	24	58190	A	57900	A	SAI
	36	58191	A	—	—	SAI
	40	58192	A	57902	A	SAI
	50	58193	A	—	—	SAI
	60	58194	Y	—	—	SAI
	80	58195	Y	—	—	SAI
	100	58196	A	57906	A	SAI
	120	58197	A	57907	A	SAI
	150	58198	A	—	—	SAI
	180	58199	A	—	—	SAI
6 x 48	24	63250	A	—	—	SAI
	36	63251	A	—	—	SAI
	40	63252	A	—	—	SAI
	50	63253	A	—	—	SAI
	60	63254	Y	—	—	SAI
	80	63255	Y	—	—	SAI
	100	63256	Y	—	—	SAI
	120	63257	Y	—	—	SAI
	150	63258	A	—	—	SAI
	180	63259	A	—	—	SAI



*Y = stock item; A = readily available by order

Abrasives - Sanding

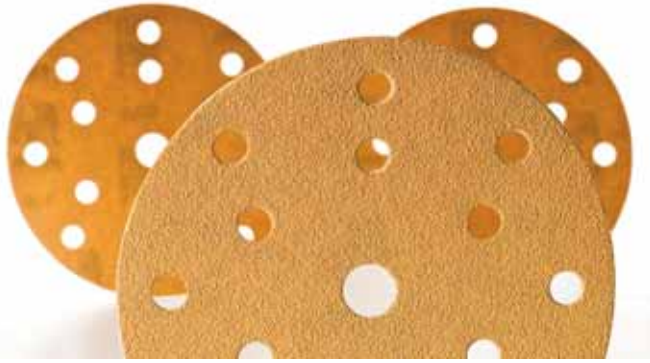
MIRKA

Random Orbit Sander Sanding Disc *Gold Brand Adhesive Products*

Manufactured from durable aluminum oxide grain, this durable, all-round sanding material is very well suited for high-speed sanding in a multitude of applications. Gold features semi-open and special stearate coatings designed to prevent clogging and pill forming, which helps achieve an optimal sanding result.

Gold 5" PSA Disc

Item #	Code	Grit	Qty./Pkg.	Stock*
23-332-036	MRK	36E	50	A
23-332-040	MRK	40E	50	A
23-332-060	MRK	60D	50	A
23-332-080	MRK	80D	100	Y
23-332-100	MRK	100D	100	Y
23-332-120	MRK	120D	100	Y
23-332-150	MRK	150D	100	Y
23-332-180	MRK	180D	100	A
23-332-220	MRK	220C	100	A
23-332-240	MRK	240C	100	A
23-332-280	MRK	280C	100	A
23-332-320	MRK	320C	100	Y
23-332-400	MRK	400C	100	A
23-332-500	MRK	500C	100	A

Gold 5" 5-Hole PSA Vacuum Disc

Item #	Code	Grit	Qty./Pkg.	Stock*
23-321-060	MRK	60D	50	Y
23-321-080	MRK	80D	100	Y
23-321-100	MRK	100D	100	Y
23-321-120	MRK	120D	100	Y
23-321-150	MRK	150D	100	Y
23-321-180	MRK	180D	100	A
23-321-220	MRK	220C	100	Y
23-321-240	MRK	240C	100	A
23-321-280	MRK	280C	100	A
23-321-320	MRK	320C	100	A
23-321-400	MRK	400C	100	A
23-321-500	MRK	500C	100	Y

Gold 5" 5-Hole Grip Vacuum Disc

Item #	Code	Grit	Qty./Pkg.	Stock*
23-614-060	MRK	60D	50	Y
23-614-080	MRK	80D	50	Y
23-614-100	MRK	100D	50	Y
23-614-120	MRK	120D	50	Y
23-614-150	MRK	150D	50	Y
23-614-180	MRK	180D	50	A
23-614-220	MRK	220C	50	Y
23-614-240	MRK	240C	50	A
23-614-280	MRK	280C	50	A
23-614-320	MRK	320C	50	A
23-614-400	MRK	400C	50	A
23-614-500	MRK	500C	50	A
23-614-AP	MRK	Assorted	50	A

Gold 5" 8-Hole Grip Vacuum Disc

Item #	Code	Grit	Qty./Pkg.	Stock*
23-615-060	MRK	60D	50	Y
23-615-080	MRK	80D	50	Y
23-615-100	MRK	100D	50	Y
23-615-120	MRK	120D	50	Y
23-615-150	MRK	150D	50	A
23-615-180	MRK	180D	50	Y
23-615-220	MRK	220C	50	Y
23-615-240	MRK	240C	50	A
23-615-280	MRK	280C	50	A
23-615-320	MRK	320C	50	A
23-615-400	MRK	400C	50	A
23-615-500	MRK	500C	50	A
23-615-AP	MRK	Assorted	50	A

Gold 5" 8-Hole PSA Disc

Item #	Code	Grit	Qty./Pkg.	Stock*
23-320-080	MRK	80	100	Y
23-320-120	MRK	120	100	Y

Gold 6" Grip Vacuum Disc

Item #	Code	Grit	Qty./Pkg.	Stock*
23-622-040	MRK	40	50	Y
23-622-060	MRK	60	50	Y
23-622-080	MRK	80	50	Y



*Y = stock item; A = readily available by order

Abrasives - Sanding



Backing Pad

For use with abrasive discs and polishing bonnets or random orbital sanders. The flexible rubber pad allows flat or contour sanding without gouging.

- 5", 8-hole pad



Item #	Code	Description	Stock*
RS031	BOS	Soft, Hook and Loop	Y
RS032	BOS	Hard, Hook and Loop	Y

Sanding Disc for Wood

Perfect for multipurpose sanding projects and hardwoods, such as oak and maple, or building boards, such as plywood. The pre-punched, eight-hole disc provides uniform dust extraction through the pad without creating unwanted swirl marks or scratches on the work surface.

- 5", 8-hole pad
- Hook and loop
- Aluminum oxide grit and resin-bonding agent



Item #	Code	Grit	Stock*
SR5R082	BOS	80	Y
SR5R125	BOS	120	Y

Sanding Disc for Paint

Perfect for paint and finish removal or sanding softer materials. The pre-punched, eight-hole disc provides uniform dust extraction through the pad without creating unwanted swirl marks or scratches on the work surface.

- 5", 8-hole pad
- Hook and loop
- Aluminum oxide grit with nonstick coating to eliminate dust clogs



Item #	Code	Grit	Stock*
SR5W042	BOS	40	Y
SR5W062	BOS	60	Y
SR5W082	BOS	80	Y
SR5W122	BOS	120	Y

Zirconium Sanding Disc

Self-sharpening Zirconia Alumina abrasive cuts three times faster and longer than standard aluminum oxide

- Grit is resin bonded to resist heat and humidity
- Heavy "F" weight backing resists tearing
- 5", 8-hole pad
- Hook and loop



Item #	Code	Grit	Stock*
ZR5B062	BOS	60	Y
ZR5B082	BOS	80	Y
ZR5B122	BOS	120	Y



PSA Sanding Disc

- 12" aluminum oxide disc with adhesive back



Item #	Code	Grit	Quantity	Stock*
31-422	DEL	80	2	Y
31-423	DEL	120	2	Y



No-Fil Adalox A290 Disc

Grit Applications

- P-graded aluminum oxide abrasive for increased life, fast cut rate and consistent finish
- Stearated (No-Fil), open coat for reduced loading
- 9" Hook and loop



Item #	Code	Grit	Stock*
0766070266	NOR	80	Y
0766070265	NOR	100	Y
07660702464	NOR	120	Y
07660702463	NOR	150	Y
66261158171	NOR	180	Y
66261156659	NOR	220	Y

Hook and Loop Sandpaper

- Hook and loop backing for hardwood floor drum sander
- 8" x 17 $\frac{3}{8}$ " sheets
- Aluminum oxide grain



Item #	Code	Grit	Stock*
100SL8V	ESS	100	Y
36SL8V	ESS	36	Y
60SL8V	ESS	60	Y
80SL8V	ESS	80	Y

Abrasives - Sanding



Drywall Pad with Abrasive Disc

Grit Applications

- 80 Grit: Textured paint removal, wall paper paste removal
- 100 Grit: Fast sanding and smoothing
- 120 Grit: All-purpose applications
- 150 Grit: Final sanding and smoothing
- 180 Grit: Light weight, quick-dry drywall sanding and smoothing, paint conditioning
- 220 Grit: Lightweight, quick-dry drywall sanding and smoothing, paint conditioning

9" Foam-Backed Pads

Item #	Code	Grit	Stock*
77085	PC	80	Y
77105	PC	100	Y
77125	PC	120	Y
77155	PC	150	Y
77185	PC	180	Y
77225	PC	220	Y



Tungsten Carbide Discs

Use to remove paint and other coatings from wood and other surfaces. All discs are 6" diameter and for use only with 18018 back-up pad.

Item #	Code	Grit	Stock*
18030	PC	24 Grit	Y
18027	PC	36 Grit	Y
18024	PC	46 Grit	Y



Sander Accessories



Item #	Code	Description	Stock*
13597	PC	4" Standard PSA Pad	Y
13700	PC	5" Standard Adhesive-Back Pad: No dust holes	Y
13900	PC	5" Quicksand™ Adhesive-Back Standard Pad: 13,000 max. rpm	Y
13901	PC	5" Quicksand™ Adhesive-Back Pad: 5 dust holes	Y
13904	PC	5" Quicksand™ Hook & Loop Standard Pad: 5 dust holes	Y
13905	PC	5" Quicksand™ Hook & Loop Contour Pad: 5 dust holes; 13,000 max. rpm	Y
13909	PC	5" Standard Hook & Loop Pad: 5- or 8-holes	Y
15000	PC	5" Hook & Loop Pad: 5 dust holes; 5/16"-24 thread shaft; 10,000 max. rpm	Y
79000	PC	Hook & Loop Foam Backing Pad for Porter Cable 7800 Drywall Sander	Y

*Y = stock item; A = readily available by order

Wire Brushes & Wheels



Knot Cup Brush

Use these rugged brushes for cleaning welds and for operating in tight spaces such as corners, angle welds and T-connections. This style is especially suited for pipe bevel cleaning.



Item #	Code	Dia.	Arbor	Max. RPM	Material	Wire Gauge	Stock*
82220P	PFE	2¾"	5/8"-11	14,000	Carbon Steel	.020	Y
82330P	PFE	2¾"	5/8"-11	14,000	Stainless Steel	.020	A
82523P	PFE	4"	5/8"-11	9,000	Carbon Steel	.023	Y

Crimped Wire Cup Brush

The crimped wire series is designed for lighter jobs where greater brush flexibility is desired. Excellent for flat surface and edge cleaning. Quickly removes light rust and oxides. Easy to handle. Heavily filled for fast brushing action.



Item #	Code	Dia.	Arbor	Max. RPM	Material	Wire Gauge	Stock*
82243P	PFE	2¾"	5/8"-11	14,000	Carbon Steel	.014	Y
82510P	PFE	4"	5/8"-11	9,000	Carbon Steel	.014	Y
82516P	PFE	3"	5/8"-11	8,000	Carbon Steel	.014	Y

Stem-Mounted Crimped Wire Bevel Brush

Brush has a concave shape for effective side cleaning action and high flexibility in lighter-duty applications, such as weld cleaning, scale, rust, paint, adhesive and oxidation removal, light deburring, and flash removal.



Item #	Code	Dia.	Shank Dia.	Max. RPM	Material	Wire Gauge	Stock*
82863P	PFE	3"	¼"	20,000	Carbon Steel	.014	Y
82878P	PFE	2"	¼"	20,000	Carbon Steel	.014	Y

Crimped Wire Wheel Brush *Unthreaded*

Heavy fill density results in more wire points for more brushing action and longer life. Designed for seamless gang mounting without parting lines.



Item #	Code	Dia.	Arbor	Max. RPM	Material	Wire Gauge	Stock*
81457P	PFE	6"	5/8", 1/2"	6,000	Carbon Steel	.014	Y
81437P	PFE	8"	5/8"	4,500	Carbon Steel	.014	Y

Full Cable Twist Knot Wheel *Threaded*

Made with larger knots than the stringer bead, this brush covers more surface in a single pass in unconfined area applications. Ruggedly constructed for heavy-duty work.



Item #	Code	Dia.	Arbor	Max. RPM	Material	Wire Gauge	Stock*
82166P	PFE	4"	5/8"-11	20,000	Carbon Steel	.020	Y

Stringer Bead Twist Knot Wheel *Threaded*

Use for stringer bead weld cleaning and other applications where a narrow (3/16") brush face is necessary to achieve the work. Widely used in nuclear power plant construction where piping, tubing and fittings are joined.



Item #	Code	Dia.	Arbor	Max. RPM	Material	Wire Gauge	Stock*
82186P	PFE	4"	5/8"-11	20,000	Carbon Steel	.020	Y

Stem-Mounted Crimped Wire End Brush

General purpose brush for working hard-to-reach places. Used for rubber and plastic flash removal, paint and rust removal, and die, mold and tool polishing.



Item #	Code	Dia.	Shank Dia.	Max. RPM	Material	Wire Gauge	Stock*
82975P	PFE	1"	¼"	20,000	Carbon Steel	.014	Y

*Y = stock item; A = readily available by order

Wire Brushes & Wheels



BOSCH

Knotted Wire Cup Brush

Single row wire brush is designed specifically for portable tools. Useful for removing weld scale, burrs and corrosion, or preparing surfaces for painting.



Item #	Code	Dia.	Arbor	Max. RPM	Material	Wire Gauge	Stock*
WB504	BOS	3"	5/8"-11	12,500	Stainless Steel	.020	Y
WB509	BOS	3"	5/8"-11	12,500	Carbon Steel	.020	Y

Knotted Wire Wheel

Full cable-knotted wire wheel has a narrow face for more difficult brushing applications. Excels in tight places, such as cleaning welds on angles or corners.



Item #	Code	Dia.	Arbor	Max. RPM	Material	Wire Gauge	Stock*
WB539	BOS	4"	5/8"-11	20,000	Stainless Steel	.020	Y
WB544	BOS	4"	5/8"-11	20,000	Carbon Steel	.020	Y

UNITED
ABRASIVES, INC.

SAIT

Knotted Wire Cup Brush

- For use on small grinders
- Knot wire for low to medium flexibility and aggressive cutting action
- Crimped carbon steel knot wire for light cleaning and where greater flexibility is required



Item #	Code	Dia.	Arbor	Max. RPM	Material	Wire Gauge	Stock*
03414	SAI	2 3/4"	5/8"-11	12,500	Carbon Steel	.014	Y

Knotted Wire Wheel

- For use on small grinders
- Regular twist covers more surface area in a single pass



Item #	Code	Dia.	Arbor	Max. RPM	Material	Wire Gauge	Stock*
03426	SAI	4"	5/8"-11	20,000	Carbon Steel	.014	Y
03460	SAI	4"	5/8"-11	20,000	Carbon Steel	.020	Y

Machinist's Files

Flat File



Tapered in width at the point and slightly tapered in thickness at the point. Flat files are double cut on both sides and are single cut on the edges. Use on ferrous and nonferrous metals for rapid stock removal.

Item #	Code	Length	Width	Thickness	Cut	Stock*
11013	PFE	12"	1 5/32"	9/32"	Bastard	Y

ADVANCE BRUSH

Mill File



Two square edges. Single cut on sides and edges. All sizes slightly tapered in width. Use for filing where a smooth finish is important, or for polishing and deburring work in lathes.

Item #	Code	Length	Width	Thickness	Cut	Stock*
19010	PFE	12"	1 5/32"	7/32"	Bastard	Y

We rent core drills
by the day, week
and month.

See our Rental
Department or
Web Site for
more information
and rates.

